

INSTALLATION MANUAL:

Jeep Gladiator OVERLAND+ and PREMIUM Lift Kits
All Lift Heights



REV: A | DATE: 03/25/2026 | AUTH: KW01

LIFT KIT OVERVIEW - 3010015

Please review the following item list for your purchased kit so you can become familiar with the included items

3010015 Jeep Gladiator Overland+ 1.5" Lift Kit (2020+, JT)	
SKU	Description
1508250	Jeep Wrangler/Gladiator 1.5" Front Coil Springs (2018+, JL/JT)
1510151	Jeep Gladiator 1.5" Triple Rate Rear Coil Springs (2020+, JT)
1409101	Jeep Wrangler/Gladiator 1-1/4" Front Bump Stops (2018+, JL/JT)
1410202	Jeep Gladiator 1" Rear Bump Stops (2020+, JT)
5109100	Jeep Wrangler/Gladiator Adjustable Front Sway Bar End Links (2018+, JL/JT)
5110110	Jeep Gladiator Adjustable Rear Sway Bar End Links (2020+, JT)
1709100	Jeep Wrangler/Gladiator Overland+ Short Front Lower Control Arms (2018+, JL/JT)
1709101	Jeep Wrangler/Gladiator Overland+ Short Front Upper Control Arms (2018+, JL/JT)
1710102	Jeep Gladiator Overland+ Short Rear Lower Control Arms (2020+, JT)
1710103	Jeep Gladiator Overland+ Short Rear Upper Control Arms (2020+, JT)
4509100	Jeep Wrangler/Gladiator Adjustable Front Track Bar (2018+, JL/JT)
4510120	Jeep Gladiator Adjustable Rear Track Bar (2020+, JT)

- **1.5" Lift:** Ideal for fitting 35" tires on a Rubicon/Mojave or 33" tires on an Overland/Willys.
 - **2.5" Lift:** Ideal for fitting 37" tires on a Rubicon/Mojave or 35" tires on an Overland/Willys.
 - **3.5" Lift:** Ideal for fitting 39" tires on a Rubicon/Mojave or 37" tires on an Overland/Willys.
- All lifts will gain approximately 1/2-1" or more lift than advertised.

Optional **HD Rear Coil Springs** are available through the "Recommended Products" tab for customers running **over 500 lbs** of weight from gear and accessories. HD rear springs will accommodate approximately **500-600 lbs** of gear before sitting below level

The following document provides general, basic instructions for the items listed above. Please navigate to a specific product page on our website for more in-depth instructions if you require a more specific, step-by-step guide

LIFT KIT OVERVIEW - 3010025

Please review the following item list for your purchased kit so you can become familiar with the included items

3010025 Jeep Gladiator Overland+ 2.5" Lift Kit (2020+, JT)	
SKU	Description
1508350	Jeep Wrangler/Gladiator 2.5" Front Coil Springs (2018+, JL/JT)
1510251	Jeep Gladiator 2.5" Triple Rate Rear Coil Springs (2020+, JT)
1408100	Jeep Wrangler/Gladiator 3-1/4" Front Bump Stops (2018+, JL/JT)
1410200	Jeep Gladiator 3" Rear Bump Stops (2020+, JT)
5109100	Jeep Wrangler/Gladiator Adjustable Front Sway Bar End Links (2018+, JL/JT)
5110110	Jeep Gladiator Adjustable Rear Sway Bar End Links (2020+, JT)
1709100	Jeep Wrangler/Gladiator Overland+ Short Front Lower Control Arms (2018+, JL/JT)
1709101	Jeep Wrangler/Gladiator Overland+ Short Front Upper Control Arms (2018+, JL/JT)
1710102	Jeep Gladiator Overland+ Short Rear Lower Control Arms (2020+, JT)
1710103	Jeep Gladiator Overland+ Short Rear Upper Control Arms (2020+, JT)
4509100	Jeep Wrangler/Gladiator Adjustable Front Track Bar (2018+, JL/JT)
4510120	Jeep Gladiator Adjustable Rear Track Bar (2020+, JT)

- **1.5" Lift:** Ideal for fitting 35" tires on a Rubicon/Mojave or 33" tires on an Overland/Willys.
 - **2.5" Lift:** Ideal for fitting 37" tires on a Rubicon/Mojave or 35" tires on an Overland/Willys.
 - **3.5" Lift:** Ideal for fitting 39" tires on a Rubicon/Mojave or 37" tires on an Overland/Willys.
- All lifts will gain approximately 1/2-1" or more lift than advertised.

Optional **HD Rear Coil Springs** are available through the "Recommended Products" tab for customers running **over 500 lbs** of weight from gear and accessories. HD rear springs will accommodate approximately **500-600 lbs** of gear before sitting below level

The following document provides general, basic instructions for the items listed above. Please navigate to a specific product page on our website for more in-depth instructions if you require a more specific, step-by-step guide

LIFT KIT OVERVIEW - 3010035

Please review the following item list for your purchased kit so you can become familiar with the included items

3010035 Jeep Gladiator Overland+ 3.5" Lift Kit (2020+, JT)	
SKU	Description
1508450	Jeep Wrangler/Gladiator 3.5" Front Coil Springs (2018+, JL/JT)
1510351	Jeep Gladiator 3.5" Triple Rate Rear Coil Springs (2020+, JT)
1408100	Jeep Wrangler/Gladiator 3-1/4" Front Bump Stops (2018+, JL/JT)
1410200	Jeep Gladiator 3" Rear Bump Stops (2020+, JT)
5109100	Jeep Wrangler/Gladiator Adjustable Front Sway Bar End Links (2018+, JL/JT)
5110110	Jeep Gladiator Adjustable Rear Sway Bar End Links (2020+, JT)
1709100	Jeep Wrangler/Gladiator Overland+ Short Front Lower Control Arms (2018+, JL/JT)
1709101	Jeep Wrangler/Gladiator Overland+ Short Front Upper Control Arms (2018+, JL/JT)
1710102	Jeep Gladiator Overland+ Short Rear Lower Control Arms (2020+, JT)
1710103	Jeep Gladiator Overland+ Short Rear Upper Control Arms (2020+, JT)
4509100	Jeep Wrangler/Gladiator Adjustable Front Track Bar (2018+, JL/JT)
4510120	Jeep Gladiator Adjustable Rear Track Bar (2020+, JT)
1309501	Jeep Wrangler/Gladiator Front Stainless Steel Brake Line Extensions (2018+, JL/JT)
1310102	Jeep Gladiator Rear Brake Lines (2020+, JT)

- **1.5" Lift:** Ideal for fitting 35" tires on a Rubicon/Mojave or 33" tires on an Overland/Willys.
 - **2.5" Lift:** Ideal for fitting 37" tires on a Rubicon/Mojave or 35" tires on an Overland/Willys.
 - **3.5" Lift:** Ideal for fitting 39" tires on a Rubicon/Mojave or 37" tires on an Overland/Willys.
- All lifts will gain approximately 1/2-1" or more lift than advertised.

Optional **HD Rear Coil Springs** are available through the "Recommended Products" tab for customers running **over 500 lbs** of weight from gear and accessories. HD rear springs will accommodate approximately **500-600 lbs** of gear before sitting below level

The following document provides general, basic instructions for the items listed above. Please navigate to a specific product page on our website for more in-depth instructions if you require a more specific, step-by-step guide

LIFT KIT OVERVIEW - 2910015

Please review the following item list for your purchased kit so you can become familiar with the included items

2910015 Jeep Gladiator PREMIUM 1.5" Lift Kit (2020+, JT)	
SKU	Description
1508250	Jeep Wrangler/Gladiator 1.5" Front Coil Springs (2018+, JL/JT)
1510151	Jeep Gladiator 1.5" Triple Rate Rear Coil Springs (2020+, JT)
1409101	Jeep Wrangler/Gladiator 1-1/4" Front Bump Stops (2018+, JL/JT)
1410202	Jeep Gladiator 1" Rear Bump Stops (2020+, JT)
5109100	Jeep Wrangler/Gladiator Adjustable Front Sway Bar End Links (2018+, JL/JT)
5110110	Jeep Gladiator Adjustable Rear Sway Bar End Links (2020+, JT)
1809100	Jeep Wrangler/Gladiator PREMIUM Short Front Lower Control Arms (2018+, JL/JT)
1809101	Jeep Wrangler/Gladiator PREMIUM Short Front Upper Control Arms (2018+, JL/JT)
1810102	Jeep Gladiator PREMIUM Short Rear Lower Control Arms (2020+, JT)
1810103	Jeep Gladiator PREMIUM Short Rear Upper Control Arms (2020+, JT)
4509100	Jeep Wrangler/Gladiator Adjustable Front Track Bar (2018+, JL/JT)
4510120	Jeep Gladiator Adjustable Rear Track Bar (2020+, JT)

- **1.5" Lift:** Ideal for fitting 35" tires on a Rubicon/Mojave or 33" tires on an Overland/Willys.
 - **2.5" Lift:** Ideal for fitting 37" tires on a Rubicon/Mojave or 35" tires on an Overland/Willys.
 - **3.5" Lift:** Ideal for fitting 39" tires on a Rubicon/Mojave or 37" tires on an Overland/Willys.
- All lifts will gain approximately 1/2-1" or more lift than advertised.

Optional **HD Rear Coil Springs** are available through the "Recommended Products" tab for customers running **over 500 lbs** of weight from gear and accessories. HD rear springs will accommodate approximately **500-600 lbs** of gear before sitting below level

The following document provides general, basic instructions for the items listed above. Please navigate to a specific product page on our website for more in-depth instructions if you require a more specific, step-by-step guide

LIFT KIT OVERVIEW - 2910025

Please review the following item list for your purchased kit so you can become familiar with the included items

2910025 Jeep Gladiator PREMIUM 2.5" Lift Kit (2020+, JT)	
SKU	Description
1508350	Jeep Wrangler/Gladiator 2.5" Front Coil Springs (2018+, JL/JT)
1510251	Jeep Gladiator 2.5" Triple Rate Rear Coil Springs (2020+, JT)
1408100	Jeep Wrangler/Gladiator 3-1/4" Front Bump Stops (2018+, JL/JT)
1410200	Jeep Gladiator 3" Rear Bump Stops (2020+, JT)
5109100	Jeep Wrangler/Gladiator Adjustable Front Sway Bar End Links (2018+, JL/JT)
5110110	Jeep Gladiator Adjustable Rear Sway Bar End Links (2020+, JT)
1809100	Jeep Wrangler/Gladiator PREMIUM Short Front Lower Control Arms (2018+, JL/JT)
1809101	Jeep Wrangler/Gladiator PREMIUM Short Front Upper Control Arms (2018+, JL/JT)
1810102	Jeep Gladiator PREMIUM Short Rear Lower Control Arms (2020+, JT)
1810103	Jeep Gladiator PREMIUM Short Rear Upper Control Arms (2020+, JT)
4509100	Jeep Wrangler/Gladiator Adjustable Front Track Bar (2018+, JL/JT)
4510120	Jeep Gladiator Adjustable Rear Track Bar (2020+, JT)

- **1.5" Lift:** Ideal for fitting 35" tires on a Rubicon/Mojave or 33" tires on an Overland/Willys.
 - **2.5" Lift:** Ideal for fitting 37" tires on a Rubicon/Mojave or 35" tires on an Overland/Willys.
 - **3.5" Lift:** Ideal for fitting 39" tires on a Rubicon/Mojave or 37" tires on an Overland/Willys.
- All lifts will gain approximately 1/2-1" or more lift than advertised.

Optional **HD Rear Coil Springs** are available through the "Recommended Products" tab for customers running **over 500 lbs** of weight from gear and accessories. HD rear springs will accommodate approximately **500-600 lbs** of gear before sitting below level

The following document provides general, basic instructions for the items listed above. Please navigate to a specific product page on our website for more in-depth instructions if you require a more specific, step-by-step guide

LIFT KIT OVERVIEW - 2910035

Please review the following item list for your purchased kit so you can become familiar with the included items

2910035 Jeep Gladiator PREMIUM 3.5" Lift Kit (2020+, JT)	
SKU	Description
1508450	Jeep Wrangler/Gladiator 3.5" Front Coil Springs (2018+, JL/JT)
1510351	Jeep Gladiator 3.5" Triple Rate Rear Coil Springs (2020+, JT)
1408100	Jeep Wrangler/Gladiator 3-1/4" Front Bump Stops (2018+, JL/JT)
1410200	Jeep Gladiator 3" Rear Bump Stops (2020+, JT)
5109100	Jeep Wrangler/Gladiator Adjustable Front Sway Bar End Links (2018+, JL/JT)
5110110	Jeep Gladiator Adjustable Rear Sway Bar End Links (2020+, JT)
1809100	Jeep Wrangler/Gladiator PREMIUM Short Front Lower Control Arms (2018+, JL/JT)
1809101	Jeep Wrangler/Gladiator PREMIUM Short Front Upper Control Arms (2018+, JL/JT)
1810102	Jeep Gladiator PREMIUM Short Rear Lower Control Arms (2020+, JT)
1810103	Jeep Gladiator PREMIUM Short Rear Upper Control Arms (2020+, JT)
4509100	Jeep Wrangler/Gladiator Adjustable Front Track Bar (2018+, JL/JT)
4510120	Jeep Gladiator Adjustable Rear Track Bar (2020+, JT)
1309501	Jeep Wrangler/Gladiator Front Stainless Steel Brake Line Extensions (2018+, JL/JT)
1310102	Jeep Gladiator Rear Brake Lines (2020+, JT)

- **1.5" Lift:** Ideal for fitting 35" tires on a Rubicon/Mojave or 33" tires on an Overland/Willys.
 - **2.5" Lift:** Ideal for fitting 37" tires on a Rubicon/Mojave or 35" tires on an Overland/Willys.
 - **3.5" Lift:** Ideal for fitting 39" tires on a Rubicon/Mojave or 37" tires on an Overland/Willys.
- All lifts will gain approximately 1/2-1" or more lift than advertised.

Optional **HD Rear Coil Springs** are available through the "Recommended Products" tab for customers running **over 500 lbs** of weight from gear and accessories. HD rear springs will accommodate approximately **500-600 lbs** of gear before sitting below level

The following document provides general, basic instructions for the items listed above. Please navigate to a specific product page on our website for more in-depth instructions if you require a more specific, step-by-step guide

DISCLAIMER

WARNING:

Suspension systems and their components are designed to enhance your vehicle's off-road performance. This may cause your vehicle to handle differently, on and off-road. Always wear your seatbelt and take extra care when driving a modified vehicle. Failure to do so can result in loss of control which may result in a rollover causing serious injury, or even death to the driver and/or passengers of the vehicle. Regular maintenance and consistent inspections are required to keep your modified vehicle safe and functioning properly. These suspension systems and any components should be installed by certified technicians only. Attempts to install these products without proper knowledge can lead to poor performance, or possible failure, which may jeopardize the safety of the vehicle and its passengers. The installer is responsible for proper installation ensuring a safe and properly functioning vehicle. Take extra care when operating a modified vehicle and thoroughly inspect your vehicle before and after every off-road use.

Read the instruction set in its entirety before attempting the installation.

NOTE:

This product may require general welding, fabrication, and automotive mechanic skills. Welding should only be done by a competent welder. Clayton Off Road implies no guarantees or warranties and is not liable for improper installation. Some grinding and fitment may be required when installing this product. Every vehicle varies slightly, and some fabrication and/or modification may be required.

ATTENTION:

It is the customer's responsibility to thoroughly inspect all received parts to ensure they are assembled correctly and fully welded. Please carefully examine all weld seams and verify that bolt-through holes are properly aligned. Some Clayton Off Road products are permanent, non-removable, weld-on solutions. **If a defect or issue is found after installation, especially with permanent weld-on components, it may be difficult or impossible to correct.** Inspecting the part(s) received beforehand helps prevent unnecessary and avoidable complications.

All Clayton Off Road products are engineered and tested on U.S. spec, left-hand drive vehicles. Compatibility with right-hand drive vehicles is not guaranteed. Customer verification is highly recommended to ensure proper fitment prior to purchase.

ATTENTION: TORQUE SPECIFICATION

When working on any vehicle, it is good practice to torque suspension/weight-bearing components while the vehicle is resting under its load. This instruction set, as well as any other Clayton Off Road instruction set, assumes the installer will tighten any suspension-related components properly, to the recommended torque specification, when the vehicle is resting safely under its own weight.

CONTROL ARM OVERVIEW

Please review the following information so you can become familiar with our purchasable options



OVERLAND PLUS

Designed for the daily driver/weekend warrior. Features dual-durometer, maintenance-free bushings for comfort on-road and capability on the trails. One of our two available suspension systems that utilize a unique mid-arm design for perfecting suspension geometry. Fully adjustable, 100% bolt on, and Made-In-The-USA with a Lifetime Warranty.



PREMIUM SERIES

Designed for the off-road enthusiast. Features both maintenance-free bushings and forged Johnny Joint adjusters for maximum versatility and flex. One of our two available suspension systems that utilize a unique mid-arm design for perfecting suspension geometry. Fully adjustable, 100% bolt on, and Made-In-The-USA with a Lifetime Warranty.

Arms, frame brackets, and hardware are identical, meaning you can swap to a different series at any point

CONTROL ARM LENGTHS

Please refer to the table below for minimum, maximum, and recommended control arm lengths. These lengths are recommendations and should only serve as a starting point for axle positioning and dialing in pinion/caster angle. **The following measurements are given as "eye-to-eye" lengths (center-to-center of joints). The desired caster angle should be somewhere between 4.5 - 6 degrees.** These are **NOT** intended as final measurements. Due to many variables, final adjustments should be made once all components are installed, then fine-tuned for your specific vehicle.

Table 1: COR Control Arm Length Specifications

Control Arm Type / Series	Minimum	1.5" Lift	2.5" Lift	3.5" Lift	4.5" Lift	Maximum
1709100 Jeep Overland+ Short Front Lower Arms	$23 - \frac{7}{8}$ "	$24 - \frac{3}{16}$ "	$24 - \frac{5}{16}$ "	$24 - \frac{1}{2}$ "	$24 - \frac{3}{4}$ "	$25 - \frac{9}{16}$ "
1709101 Jeep Overland+ Short Front Upper Arms	$19 - \frac{3}{4}$ "	$20 - \frac{3}{16}$ "	$20 - \frac{1}{4}$ "	$20 - \frac{3}{8}$ "	$20 - \frac{9}{16}$ "	$21 - \frac{1}{8}$ "
1710102 Jeep Overland+ Short Rear Lower Arms	$23 - \frac{7}{16}$ "	$23 - \frac{7}{8}$ "	24"	$24 - \frac{1}{8}$ "	$24 - \frac{1}{4}$ "	$25 - \frac{1}{8}$ "
1710103 Jeep Overland+ Short Rear Upper Arms	$16 - \frac{1}{16}$ "	$16 - \frac{1}{2}$ "	$16 - \frac{9}{16}$ "	$16 - \frac{3}{4}$ "	$16 - \frac{15}{16}$ "	$17 - \frac{7}{16}$ "
1809100 Jeep Premium Short Front Lower Arms	24"	$24 - \frac{3}{16}$ "	$24 - \frac{5}{16}$ "	$24 - \frac{1}{2}$ "	$24 - \frac{3}{4}$ "	$24 - \frac{7}{8}$ "
1809101 Jeep Premium Short Front Upper Arms	$19 - \frac{5}{8}$ "	$20 - \frac{3}{16}$ "	$20 - \frac{1}{4}$ "	$20 - \frac{3}{8}$ "	$20 - \frac{9}{16}$ "	$22 - \frac{1}{4}$ "
1810102 Jeep Premium Short Rear Lower Arms	$23 - \frac{13}{16}$ "	$23 - \frac{7}{8}$ "	24"	$24 - \frac{1}{8}$ "	$24 - \frac{1}{4}$ "	$24 - \frac{9}{16}$ "
1810103 Jeep Premium Short Rear Upper Arms	$16 - \frac{3}{8}$ "	$16 - \frac{1}{2}$ "	$16 - \frac{9}{16}$ "	$16 - \frac{3}{4}$ "	$16 - \frac{15}{16}$ "	$17 - \frac{5}{8}$ "

FRONT-END INSTALLATION

The following instructions are a generic guide to installing the front-end components. Please navigate to a specific product page for more in-depth instructions if you require a more specific, step-by-step guide



INSTALLATION INSTRUCTIONS

Take this product to a licensed professional if you are hesitant about the installation process!

The following instructions apply to the listed components below:

- Front Coil Springs (1.5", 2.5", 3.5", 4.5")
- Front Adjustable Track Bar
- Front Control Arms (Overland+ or Premium)
- Front Bump Stops
- Front Sway Bar End Links
- Front Brake Line Extension Brackets (for 3.5"+ kits only)

The following instructions provide a basic guide for installing the front-end components for the mid-arm lift kit!

If you purchased items separately or swapped in other components, your installation process will vary.

We strongly recommend having basic mechanic's hand tools, sockets, wrenches, vehicle jacks and stands, and other common tools readily available. Installing an aftermarket lift kit is a detailed process, and having the right tools on hand will ensure a smoother installation.

As always, feel free to contact us at any point during your installation - you can count on us to help!

INSTALLATION INSTRUCTIONS

TOOLS REQUIRED FOR INSTALLATION

- *Basic hand tools*
- *Hex key set*
- *Metric wrench/socket set*
- *Standard wrench/socket set*
- *Large box wrenches* (Large adjustable OR 1-1/2", 1-7/8")
- *Adjustable wrench*
- *Torque wrench*
- *Jack stands and/or vehicle lift*

1. Position the vehicle either on the ground or on a lift. For this installation, it is recommended that the vehicle be supported by the frame. Support the front axle with two additional jack stands. Remove the front tires and set aside.



Figure 1: Front axle supported with two adjustable jack stands and tires removed

*****Photos of control arm adjusters in the following photos may not match your selected series, but the installation remains the same!*****

INSTALLATION INSTRUCTIONS

2a. Remove the OEM engine guard cross bar using an 18mm socket. Put this member and the hardware off to the side for now. Removing this cross member will provide more room to work. **The skid plate can and should be reinstalled at the end of the installation.** The cross member may change based on year, make, and model.

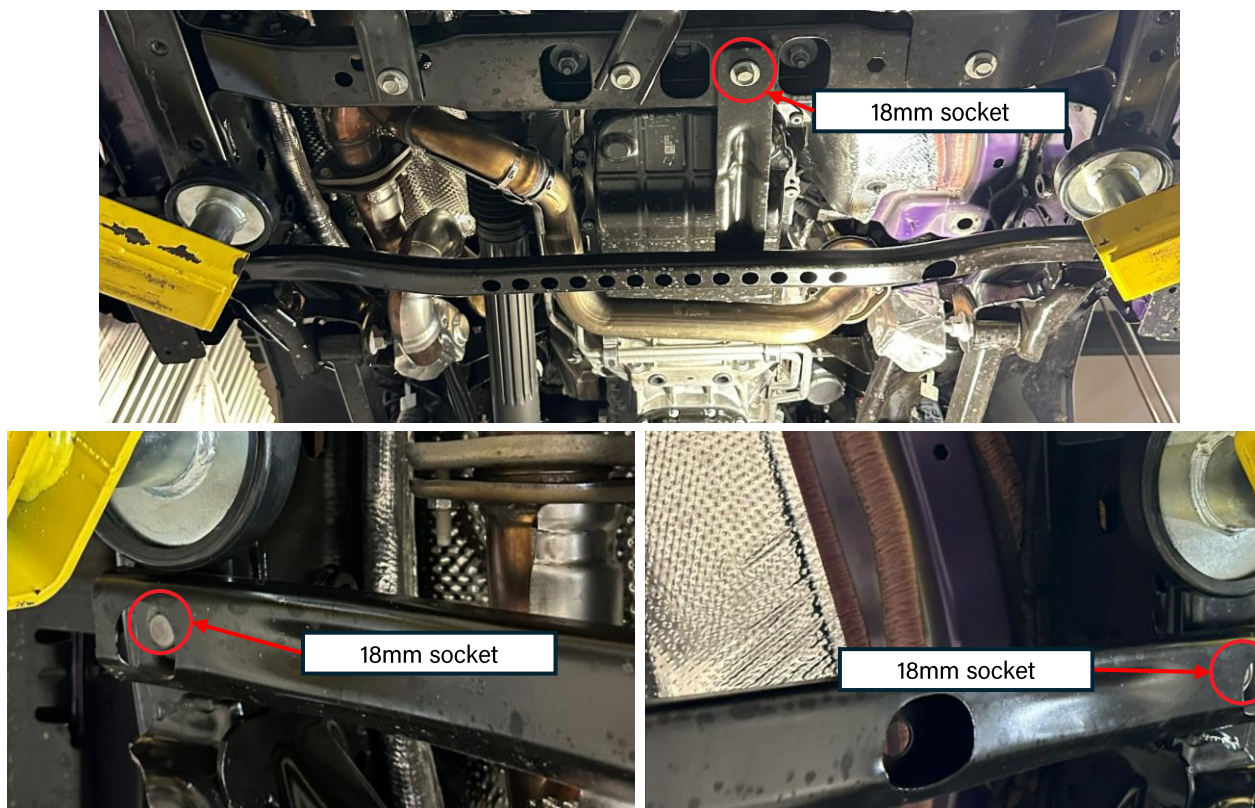

Figure 2a: Engine guard cross bar to be removed (2026 JT Mojave)

INSTALLATION INSTRUCTIONS

2b. **2026+ VEHICLE NOTE:** Temporary removal of the vehicle's frame crash-brackets are required for this installation. Most 2026 vehicles have this bracket on the front driver/passenger side. Using an **18mm socket**, remove the 9 bolts fastening the crash bracket to the frame. There are 3 bolts on the outside of the frame, 4 bolts near the wheel, and 2 bolts hidden on the bottom side of the frame rail. **The crash brackets can and should be reinstalled at the end of the installation.**

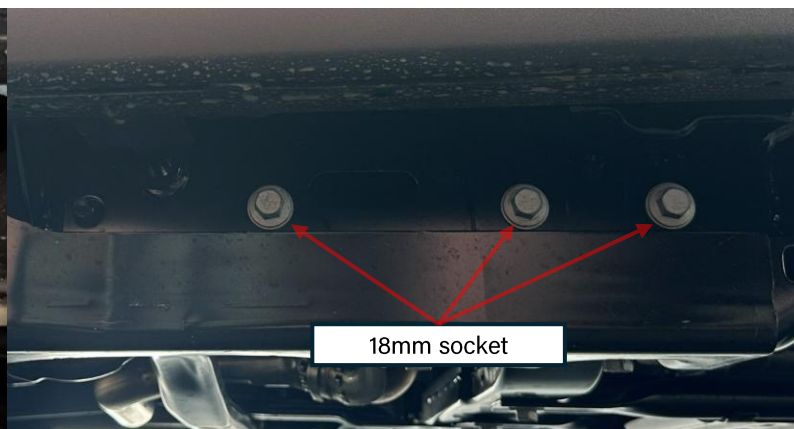
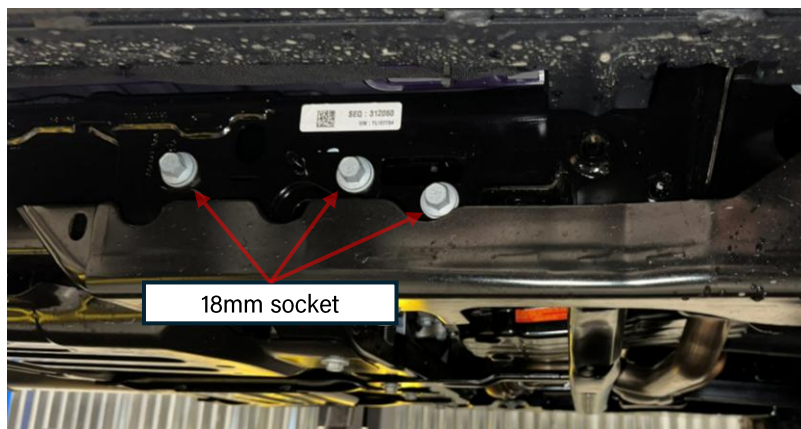

Figure 2b: passenger/driver side crash bracket bolts to remove (3 on each side) (2026 JT Mojave)

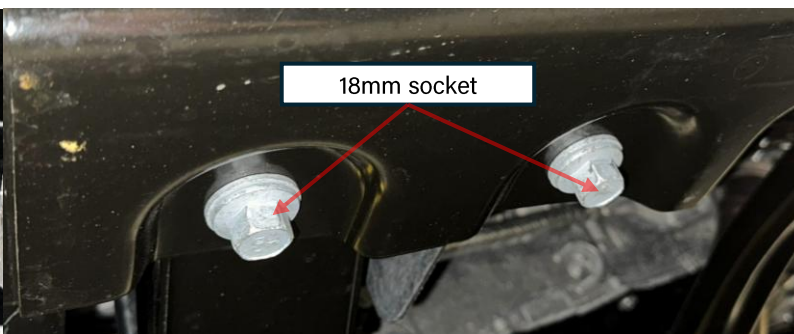
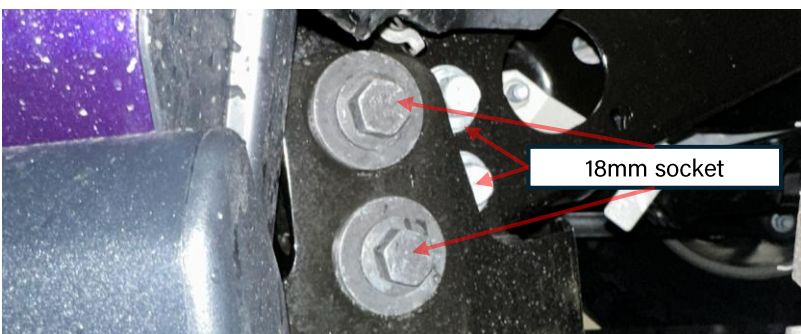

Figure 2c: 4x bolts near wheel well and 2x bolts on underside of frame (2026 JT Mojave)

INSTALLATION INSTRUCTIONS

3. Remove the factory front sway bar end-links. The socket size may vary depending on which vehicle, year, or aftermarket components you may already have installed. **Use an 18mm socket/wrench if OEM.** Put the hardware aside and tuck the sway bar up and out of the way.

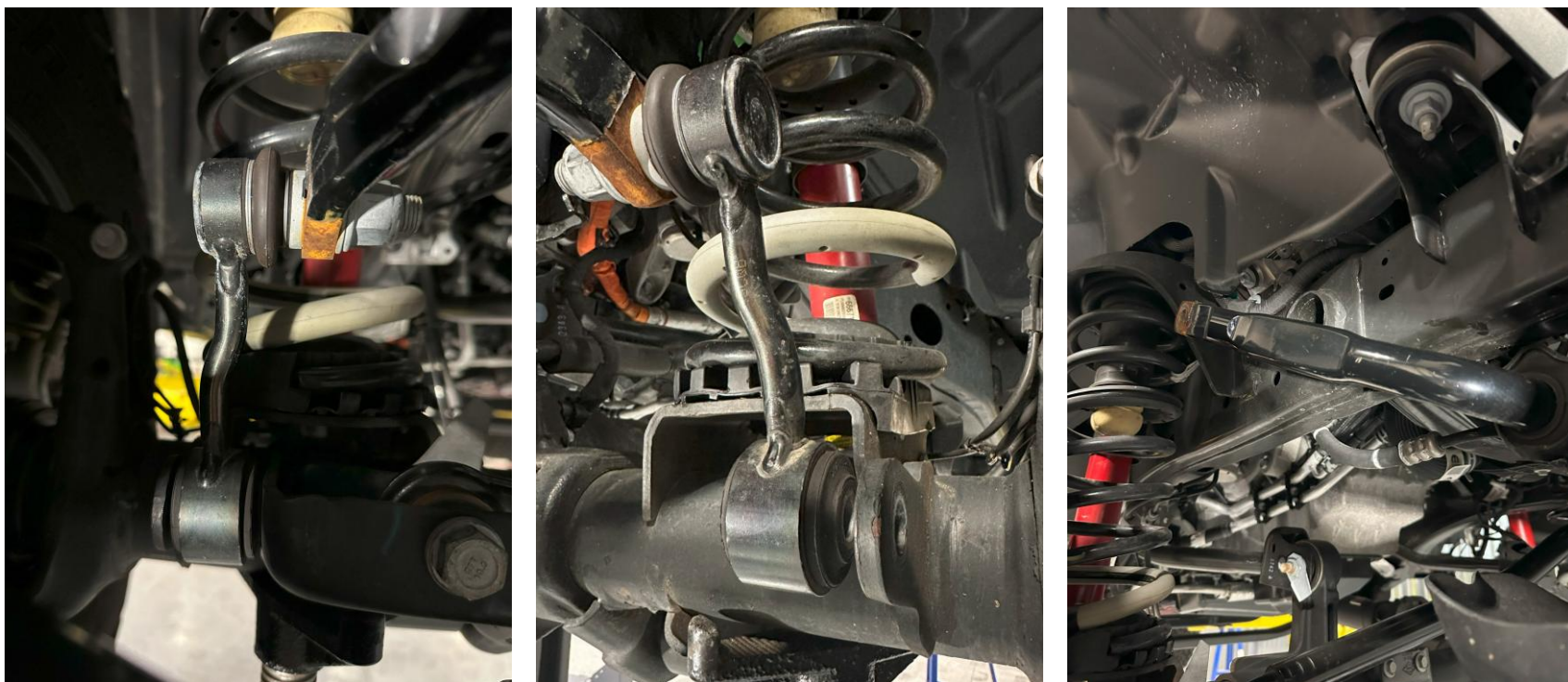

Figure 3: Front passenger and driver-side sway bar end link to be removed, with sway bar tucked up and away

INSTALLATION INSTRUCTIONS

4. Remove the lower shock bolts using an 18mm socket. Save the hardware and put it aside. Move to the top of the shocks and remove the top shock bolts with an 18mm socket (if you are replacing the shocks). It may be hard to access, so push the fender liner out of the way and use a socket extension. You may need to notch or cut the fender liner with a knife/blade to obtain enough clearance. Remove the shocks completely if you are installing new shocks.

If you are retaining the original shocks, you only have to remove the bottom shock bolt.

NOTE: Clayton Off Road provides a replacement M12-1.75mm bolt for the front lower shock bolt. The bolt is provided with our lower control arms, COR-1709100 or COR-1809100. Refer to the control arm product instructions for more details.



Figure 4: Front driver/passenger lower shock bolts removed



Figure 5: Front upper passenger shock bolt removed

NOTE: Mojave owners will have larger shock hardware. Use a 21mm wrench/socket to remove the bolts.

INSTALLATION INSTRUCTIONS

5. Remove the brake line bracket off the front lower control arms using a 15mm socket and let the bracket hang. Then, remove the front upper control arm heat shields from both sides. **2x, 10mm bolts** retain each heat shield. One bolt is located on the side, the other on the top (hidden). The top bolt is hard to get to, so use a small ratchet or ratcheting socket. Put the heat shields aside, as they can be reinstalled later.



Figure 6: Front driver/passenger lower brake line mount removed

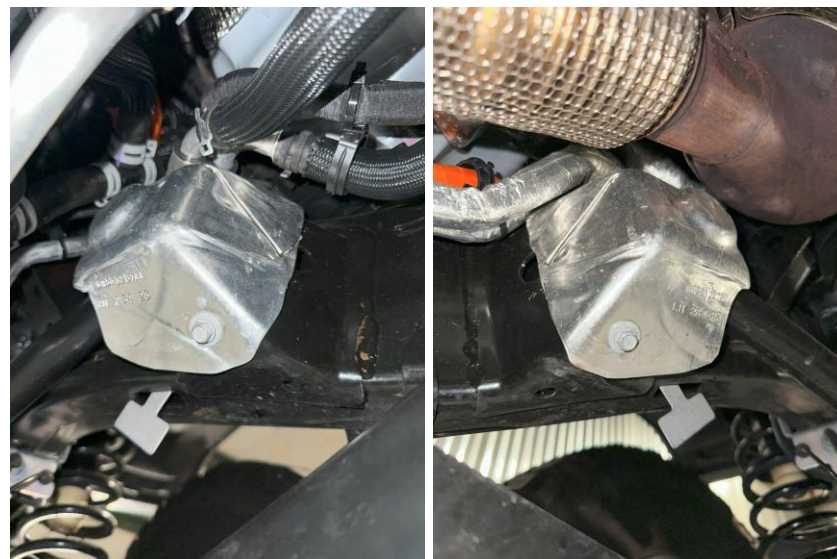

Figure 7: Front upper control arm heat shields to be removed

TIP: Remove the upper brake line bracket from the frame to ensure that the brake lines do not strain when the axle is lowered. You may also remove all the Christmas-tree plastic clips that retain the ABS cable.

INSTALLATION INSTRUCTIONS

6. Remove the front factory track bar. Start with the frame bracket bolt (21mm) and then the axle bolt (21mm).

Unplug the differential sensor, and remove the breather tube. Also, remove the plastic push-clip from the upper factory control arm. Put the hardware aside, as it will be reused.



Figure 8: Front factory track bar bolts locations (left) and wiring harness/breather hose and plastic clips (right)

INSTALLATION INSTRUCTIONS

7. Loosen the control arm bolts in the front end, **but do not remove them**. You will need 18mm, 21mm, and 24mm sockets. **Make sure that the axle remains supported. Try to minimize any axle shift that may occur during this process.**

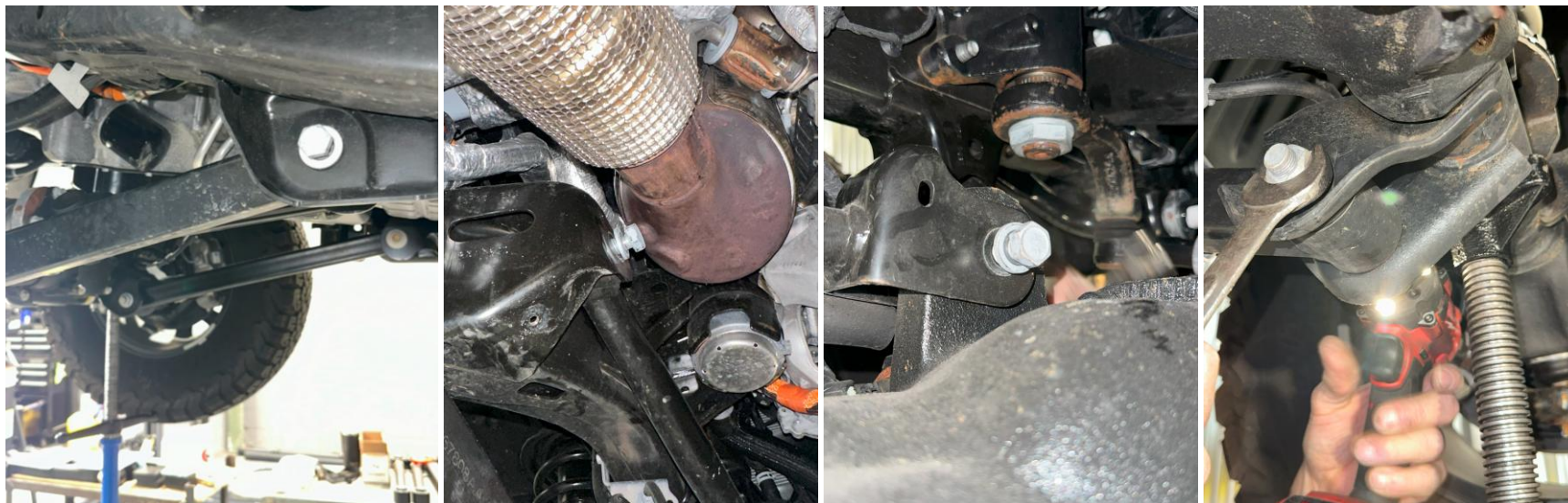

Figure 9: Lower/upper frame-side control arm bolts, and lower/upper axle-side control arm bolts

INSTALLATION INSTRUCTIONS

8. Droop the axle by lowering the supporting jack stands (or raising the vehicle) and remove the factory springs to install the new bump stops. Use the included hardware and use a $\frac{5}{16}$ " hex key and $\frac{9}{16}$ " wrench. Complete both sides at this time. **You may tighten the bump-stop hardware at this time. Retain the spring isolator, as it will be reused.**



Figure 10: Axle drooped with old springs removed, and bump stops installed

TIP: Tape the nut to the wrench to get the threads started, as the nut may be hard to hold at the spring perch hole.

OPTIONAL TIP: If the factory coils had isolators on the coil rungs, carefully tear them off the old coils. Using the OEM coils as reference, install them onto the new coils at (or near) the OEM locations. Use a strong adhesive to secure the isolators to the new coils.

INSTALLATION INSTRUCTIONS

9. Install the new front springs. **The last two digits etched on the front coils should read xxxxx50.** The front coils for this kit are **NOT** side-specific. Install the new springs while the axle is still dropped. Make sure that the springs are set properly on the coil perch and are retained in the upper spring mount. **Ensure the spring isolator is installed at this time.**

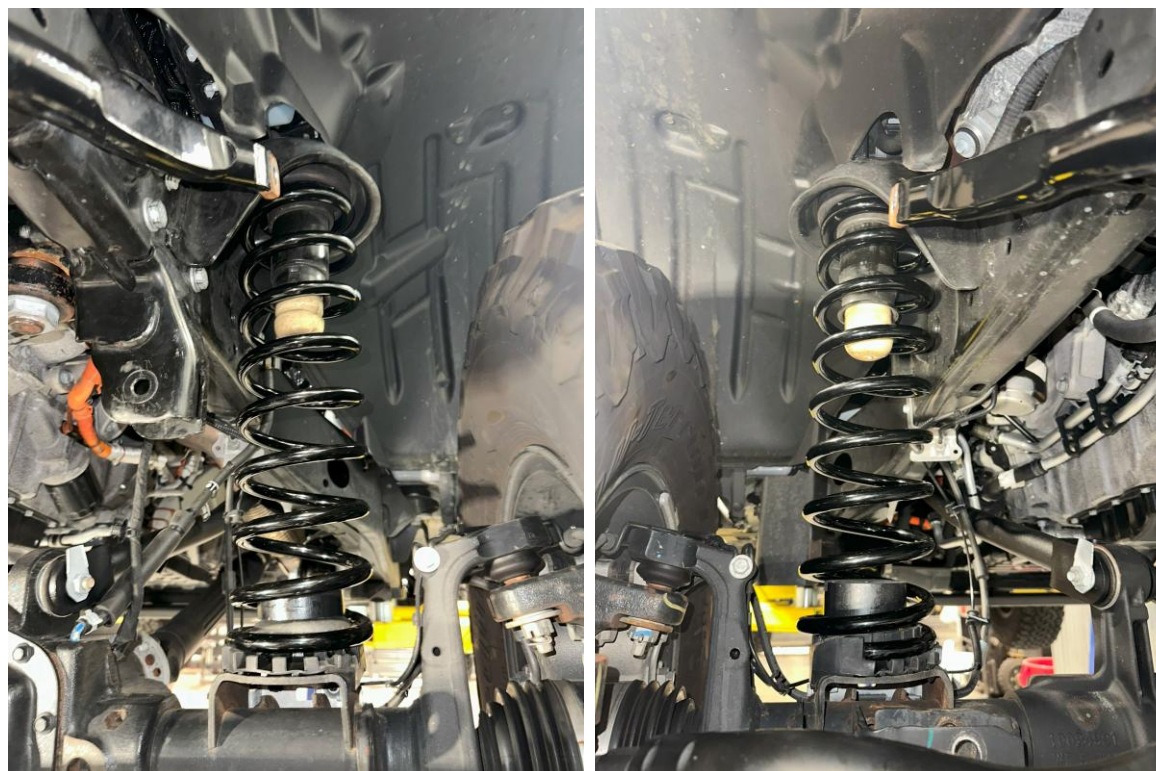

Figure 11: New springs installed and seated properly

INSTALLATION INSTRUCTIONS

10. Re-install the front shocks or install new shocks. Install the upper bolt first, then the lower axle bolt. Use original hardware, unless your new shocks came with new hardware. If the aftermarket shocks came with a piggyback reservoir, install them at this time. **Do not torque yet.**

NOTE: In Figure 12 below, the provided M12-1.75mm bolts were used with the bolt head facing the tires at the lower shock mounts. These bolts are provided to give proper clearance for the new lower square control arms.

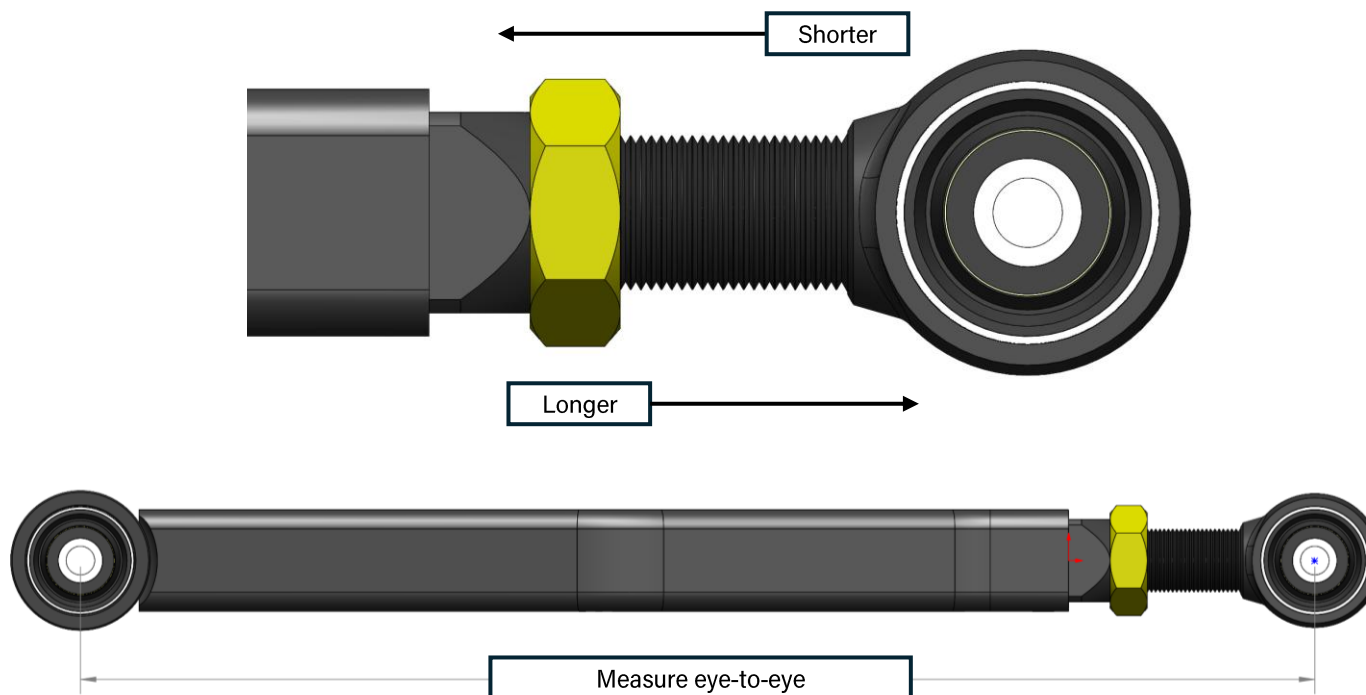

Figure 12: Front shock top and bottom bolt installed loosely

INSTALLATION INSTRUCTIONS

11. Determine the appropriate length of the new control arms based on your vehicle's ride height and your desired pinion and caster angles. Use the lengths provided at the beginning of these instructions as a starting point or reference our **JT Suspension Quick Guide**. **For this lift kit, the front uppers are round, and the front lowers are square.**

Adjust the end-forging by screwing it in or out. **Measure the length from eye-to-eye, or center of bushing to center of bushing.** When the desired length is met, spin the jam nut down to the control arm to lock the forging into position.



INSTALLATION INSTRUCTIONS

12. Remove the lower control arms first. Complete one side at a time. Install the new lower control arms on both sides, with the bend in the arms providing clearance for the tires. The adjusters should be located on the frame side. **The lower arms are not side-specific, but they must be the same length.** When installed properly, the bends in the arms should be pointing in and away from the frame of the vehicle. **See our Control Arm Quick Guide for more information. Do not torque yet.**

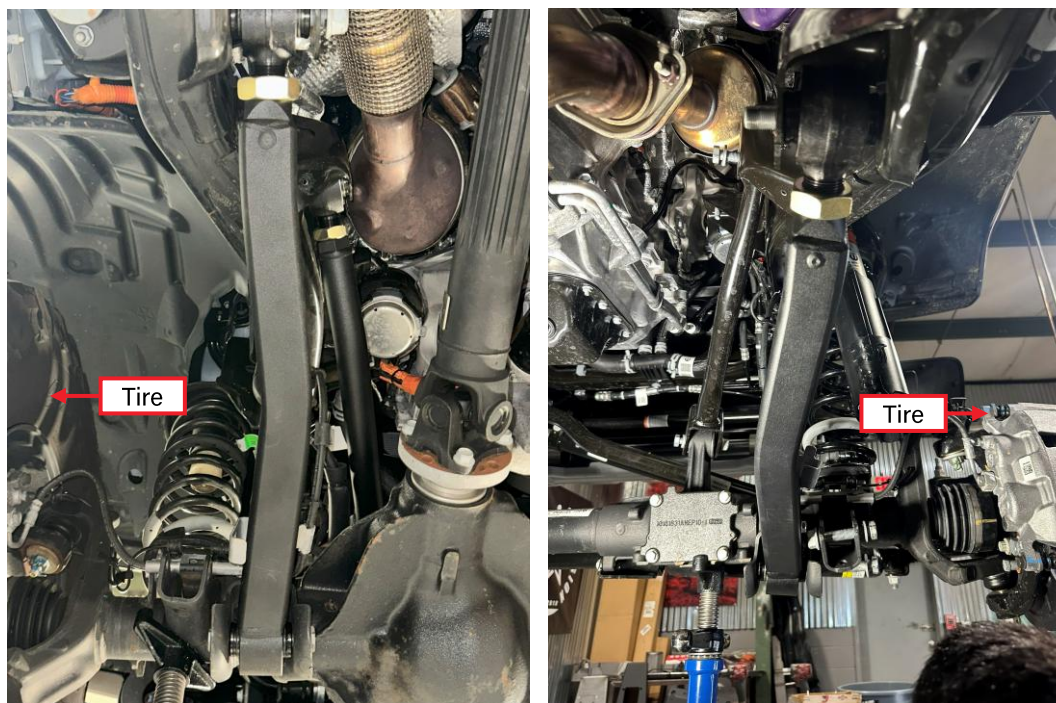

Figure 13: New driver-side control arm installed with original hardware

NOTE: The vehicle in the installation above was receiving shock extensions. Thus, the shocks were left uninstalled for now.

INSTALLATION INSTRUCTIONS

13. Remove the upper control arm on the driver side. **The passenger side upper arm will hold the pinion at its current angle. Ensure that the OEM passenger side upper arm is loosely installed.**

The vehicle will be returned to the ground (or a 4-post lift) at the end of the installation to dial in the caster angle and torque suspension bolts to specification. Only then should the passenger OEM upper control arm be removed, and the new Clayton upper control arms be installed (with the pinion supported)

If the new upper arms are forced into place, binding in the bushings can occur, potentially leading to a variety of issues. Wait until the end of these instructions to install the new upper arms and dial the caster angle.

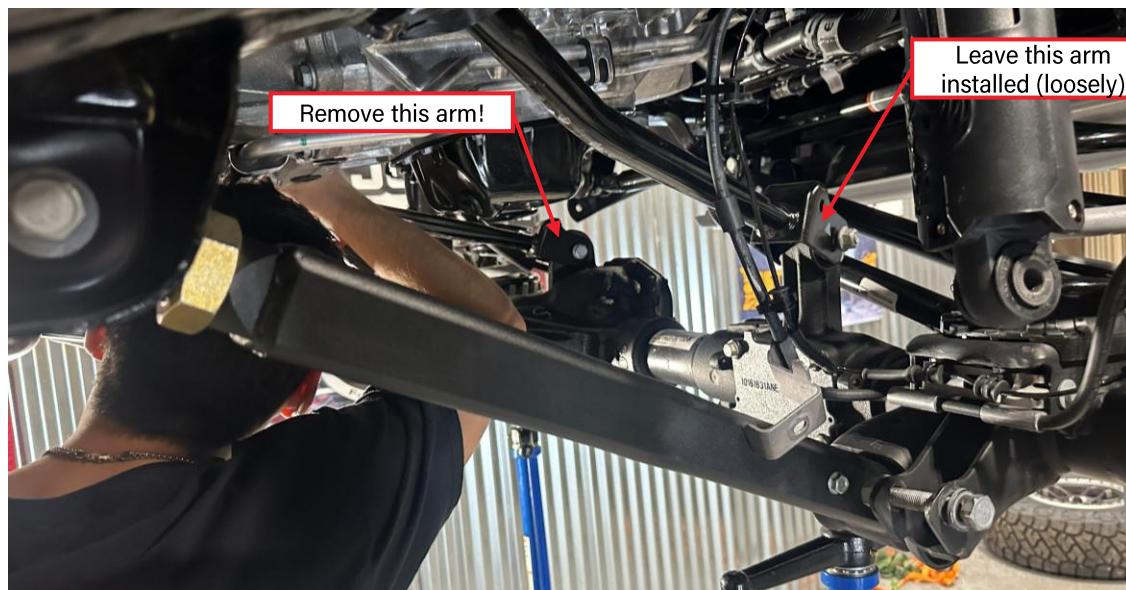

Figure 14: Removing the driver-side upper arm

INSTALLATION INSTRUCTIONS

14. Reattach the brake line brackets and all of the plastic christmas-tree clips. Use the provided self-tapping screw that is already installed in the new control arms to secure the bracket. Reuse the mounting bolt for the brake bracket at the coil bucket, and the frame. Use a ½" socket to remove the screw.

For lift kits with 3.5"+, please use the supplied brake line extension bracket as seen in the photo on the right.

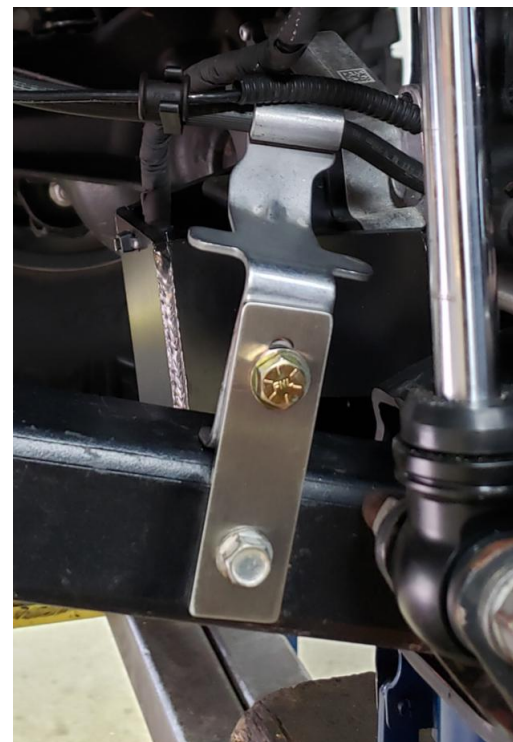
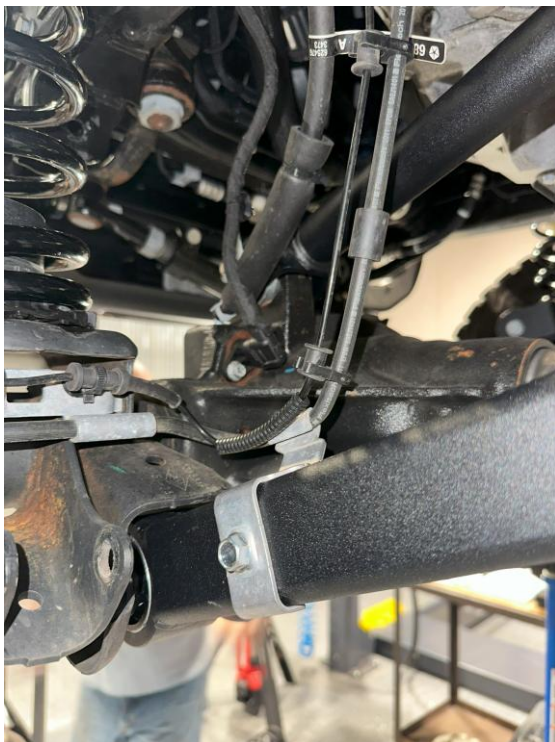

Figure 15: Brake line brackets secured (Brake line extension bracket on far right, only supplied in 3.5"+ kits)

INSTALLATION INSTRUCTIONS

15. Install the new front track bar. Follow the **JT Suspension Quick Guide** for more information, such as starting lengths based on coil height. You can find this quick guide on our website under any JT lift kit listing, or details at the end of these instructions. Use a 21mm socket and wrench to install the track bar. Put the hardware aside, as it will be reused.

Do not torque yet. Install the axle bolt first, then the frame bolt using the original hardware.

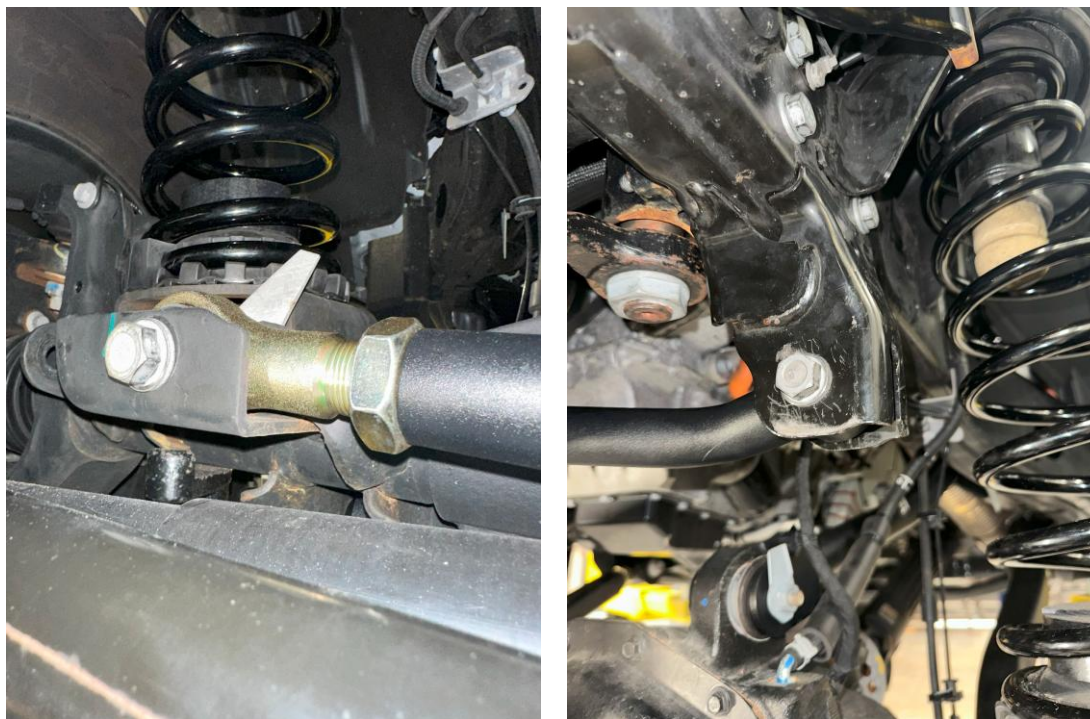

Figure 16: New front track bar installed

INSTALLATION INSTRUCTIONS

16. Cut the new sway bar rods to the recommended length at each end following the **Sway Bar Quick Guide**. You can find this quick guide on our website, or details at the end of these instructions. Assemble the sway bar end-links and use a 6mm hex key and an 18mm wrench to install. Reuse the factory bolt for the passenger axle-side connection with the Heim joint.

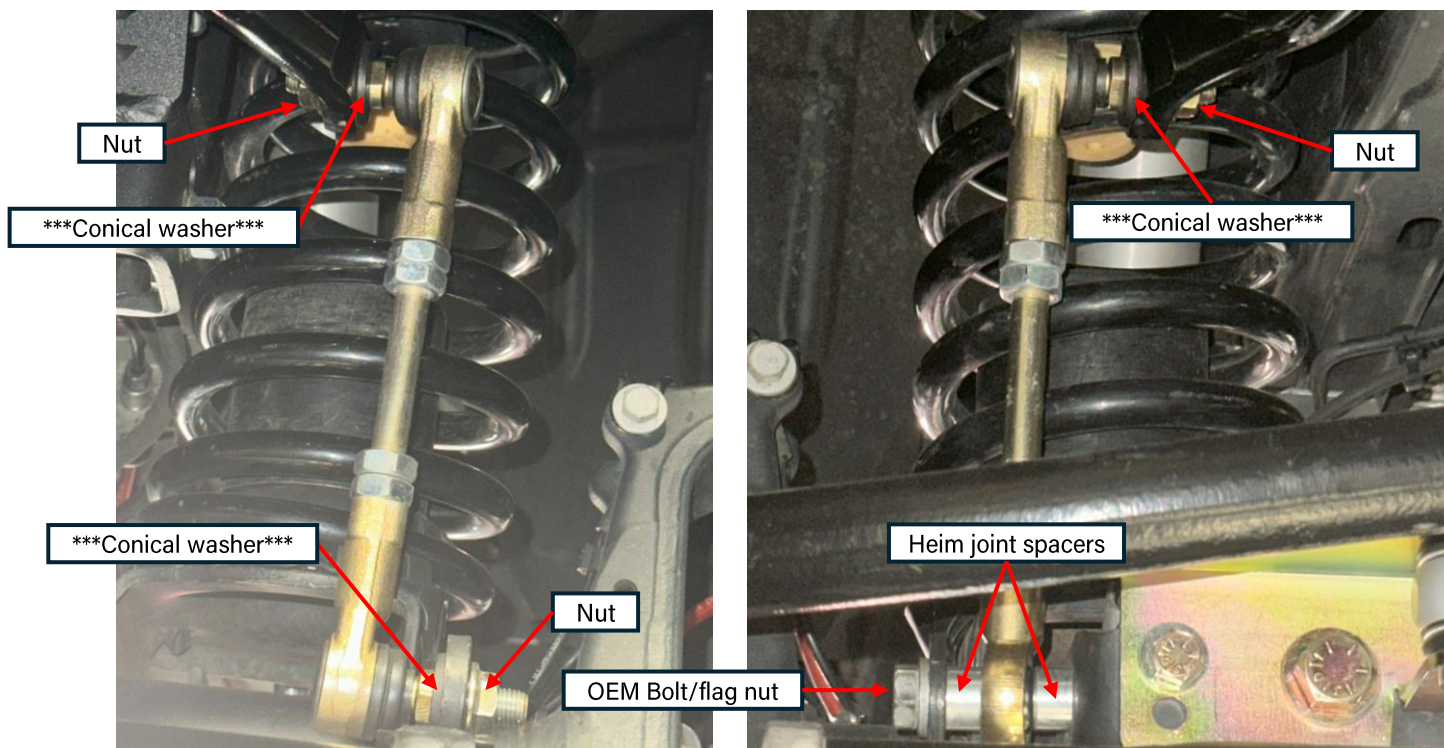

Figure 17: Front driver-side and passenger side sway bar end link proper orientation

*****Conical washers installed with the concave side facing towards the sway bar, NOT the link!*****

INSTALLATION INSTRUCTIONS

17. Reinstall the front axle wiring harness and breather hose. Use pliers to pinch the hose clip and slip the hose over the stem.

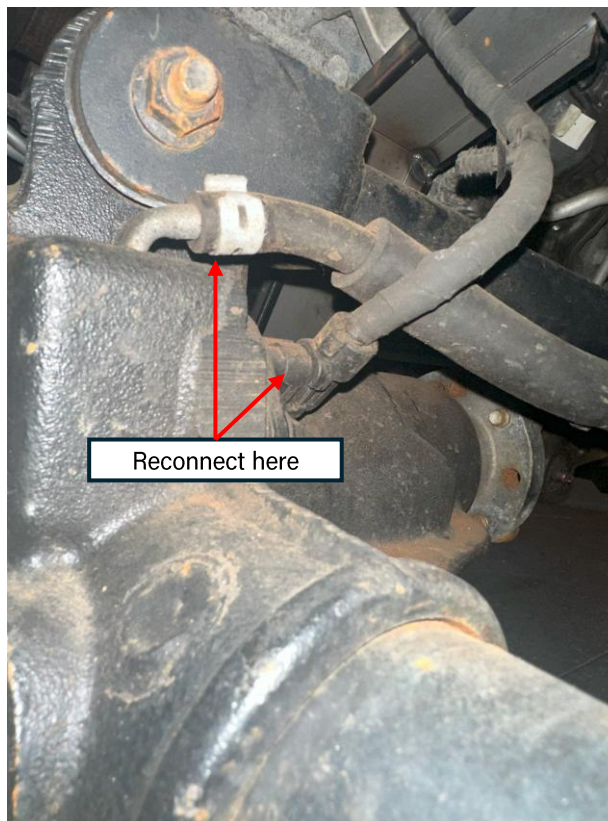

Figure 18: Front axle wiring harness/breather hose reconnected

REAR-END INSTALLATION

The following instructions are a generic guide to installing rear-end components. Please navigate to a specific product page for more in-depth instructions if you require a more specific, step-by-step guide



INSTALLATION INSTRUCTIONS

Take this product to a licensed professional if you are hesitant about the installation process!

The following instructions apply to the listed components below:

- Rear Coil Springs (1.5", 2.5", 3.5", 4.5")
- Rear Adjustable Track Bar
- Rear Control Arms (Overland+ or Premium)
- Rear Bump Stops
- Rear Sway Bar End Links

The following instructions provide a basic guide for installing the rear-end components for the mid-arm lift kit!

If you purchased items separately or swapped in other components, your installation process will vary.

We strongly recommend having basic mechanic's hand tools, sockets, wrenches, vehicle jacks and stands, and other common tools readily available. Installing an aftermarket lift kit is a detailed process, and having the right tools on hand will ensure a smoother installation.

As always, feel free to contact us at any point during your installation - you can count on us to help!

INSTALLATION INSTRUCTIONS

18. Move to the rear of the vehicle. Remove the tires for additional clearance. For the rear installation, a lot of the same steps will be followed. You will want to pay close attention when the axle is dropped so as not to stretch or strain any cables or hoses. Proceed to the next step.



Figure 19: Rear tires removed, axle drooped

INSTALLATION INSTRUCTIONS

19. Support the rear axle. For this installation, it is recommended that the vehicle be supported by the frame. Support the rear axle with two additional jack stands. You will want to leave enough adjustment in the jack stands to droop the axle further to remove the springs (after other suspension components are loosened).

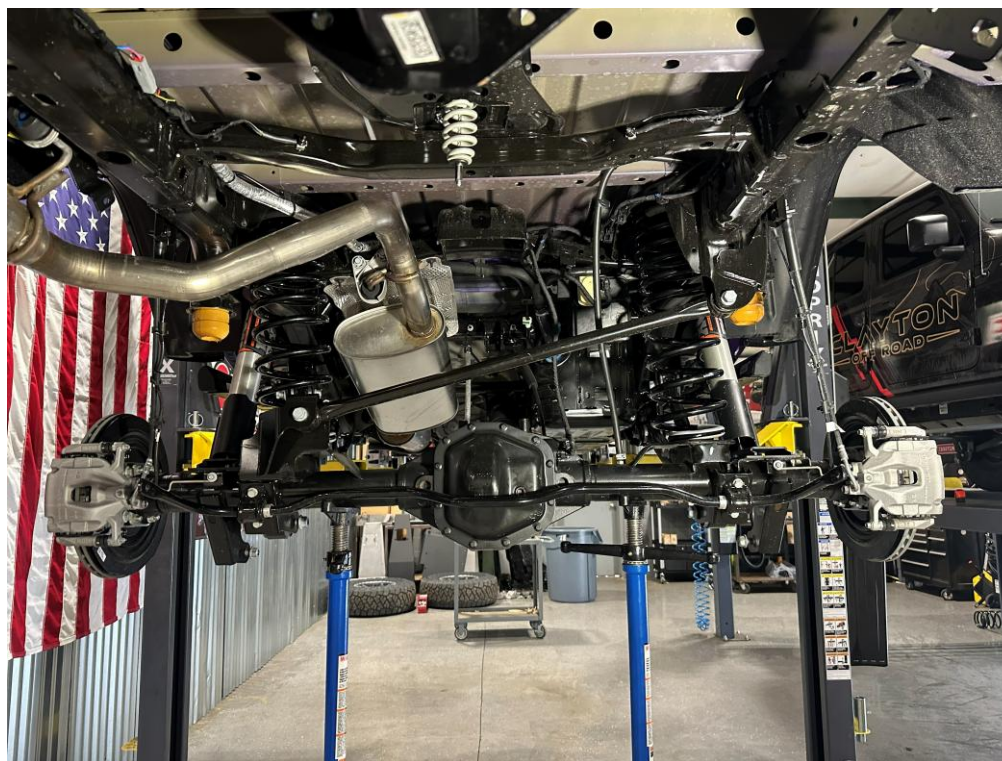

Figure 20: Rear axle tires removed, axle supported and drooped

INSTALLATION INSTRUCTIONS

20. Remove the lower shock bolts using an 18mm socket. Save the hardware and put it aside. Move to the top of the shocks and remove the top shock bolts with an 18mm socket (if you are replacing the shocks). It may be hard to access, so push the fender liner out of the way and use a socket extension. You may need to notch or cut the fender liner with a knife/blade to obtain enough clearance. Remove the shocks completely if you are installing new shocks.

If you are retaining the original shocks, you only have to remove the bottom shock bolt.

NOTE: Mojave vehicles will have larger shock hardware. Use a 21mm wrench/socket to remove the bolts.

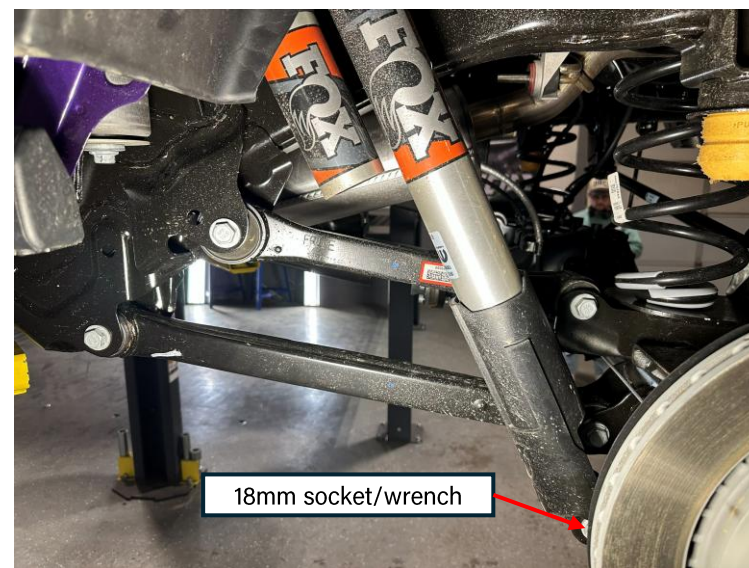

Figure 21: Rear passenger/driver-side lower shock bolts to be removed

INSTALLATION INSTRUCTIONS

21. Remove the factory rear sway bar end links. The socket size may vary depending on which vehicle, year, or aftermarket components you may already have installed. Remove the upper and lower bolts on both sides. You will be reusing the hardware. **Remove the differential harness and breather hose. Be gentle with the clip, pull the lock-tab out first then slowly wiggle it off the sensor.**

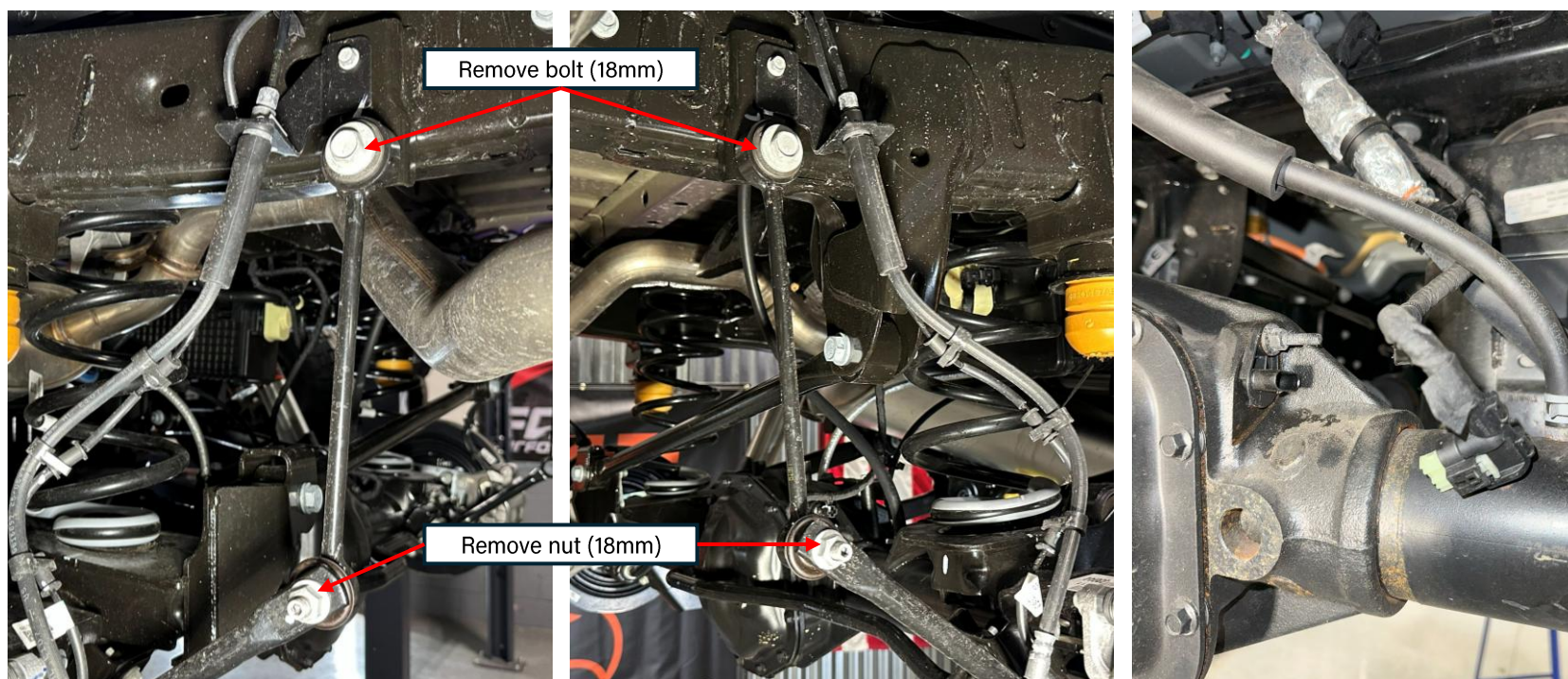

Figure 22: Rear passenger/driver sway bar end link before removal, and differential sensor and hose removed

INSTALLATION INSTRUCTIONS

22. Remove the factory rear track bar. Start with the frame bracket bolt (21mm) and then the axle bolt (21mm). Save all factory hardware, as it will be reused. **Note that the track bar connection at the axle has a tab nut on the backside of the bracket.** **Save ALL hardware for the new track bar installation.**

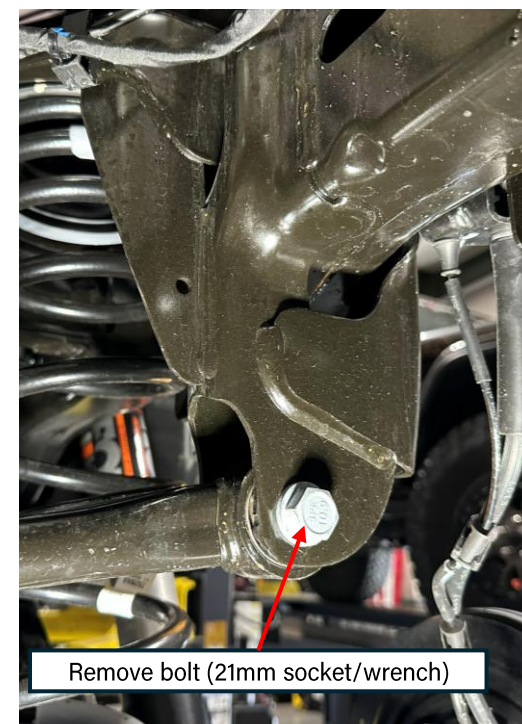
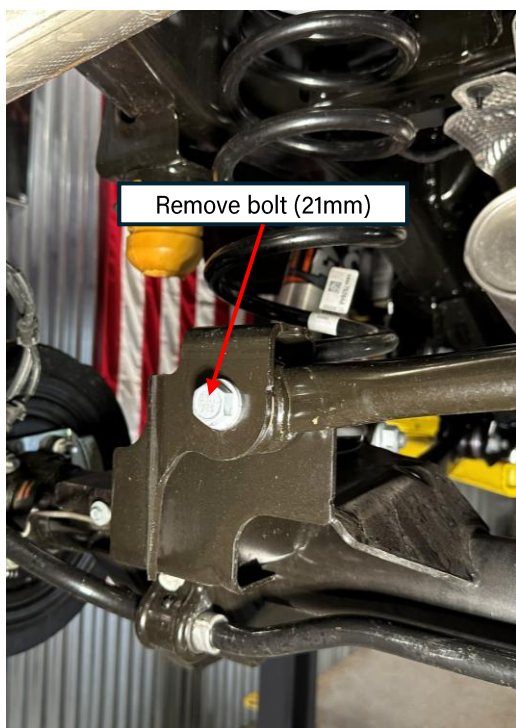

Figure 23: Rear track bar bolt locations before removal

INSTALLATION INSTRUCTIONS

23. Loosen all 8 rear control arm bolts, but **do not remove at this time.** You will need 18mm, 21mm, and 24mm sockets. **Make sure that the axle remains supported. Try to minimize any axle shift that may occur during this process.**

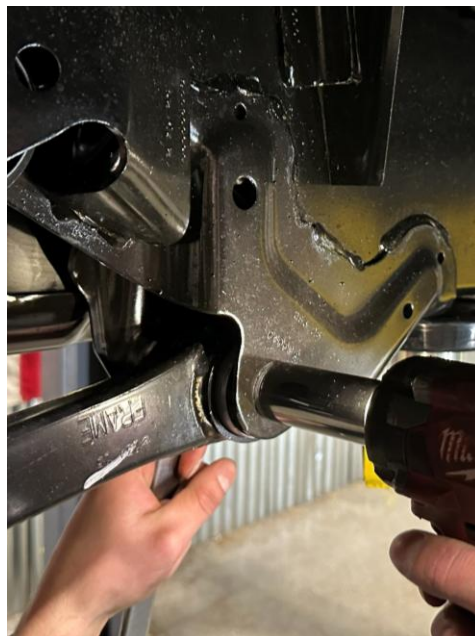

Figure 24: Rear control arm bolt locations (2 arms each side, 4 bolts per side, or 8 bolts total)

INSTALLATION INSTRUCTIONS

24. Carefully droop the axle by lowering the supporting jack stands (or raising the vehicle) and remove the factory springs. Using the OEM spring boot, install the new springs. Complete both sides at this time. **The last two digits etched on the rear coils should read xxxxx51.** The rear coils in this kit **ARE NOT** side-specific. Install the new springs while the axle is still dropped. Make sure that the springs are set properly on the coil perch and are retained in the upper spring mount.

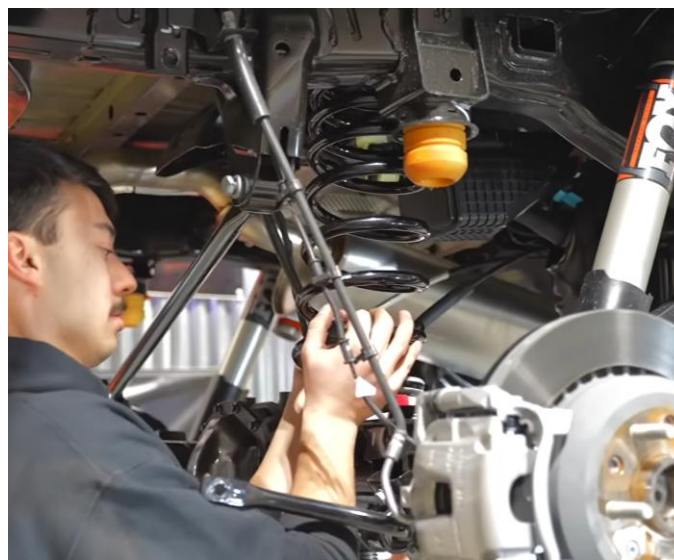
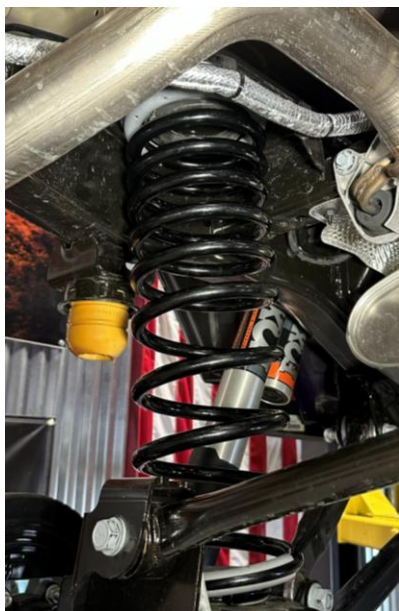
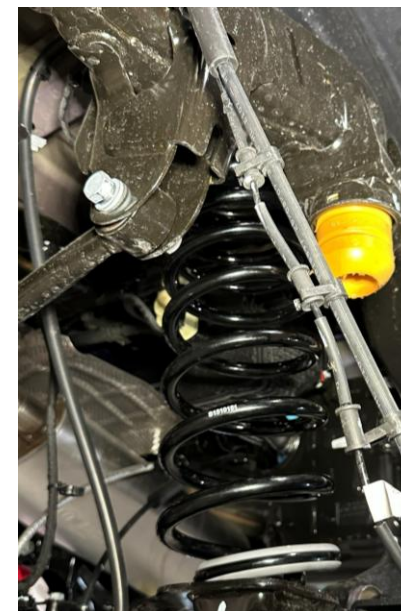

Figure 25: New, side-specific springs replaced



NOTE: Our HD coils are also **NOT** side-specific. If you are installing HD coils on your heavier, fully loaded vehicle, you do not need to worry about left or right-side coil installation.

INSTALLATION INSTRUCTIONS

25. Reinstall the rear shocks or install new shocks. Install the upper bolt first, then the lower axle bolt. Use original hardware, unless your new shocks came with new hardware. If the aftermarket shocks came with a piggyback reservoir, install them at this time. **Do not torque yet.**

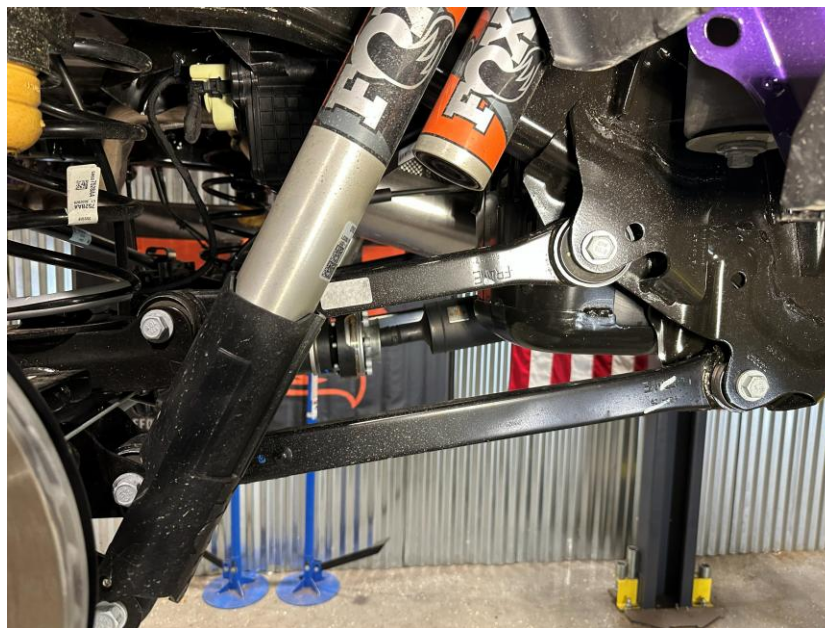
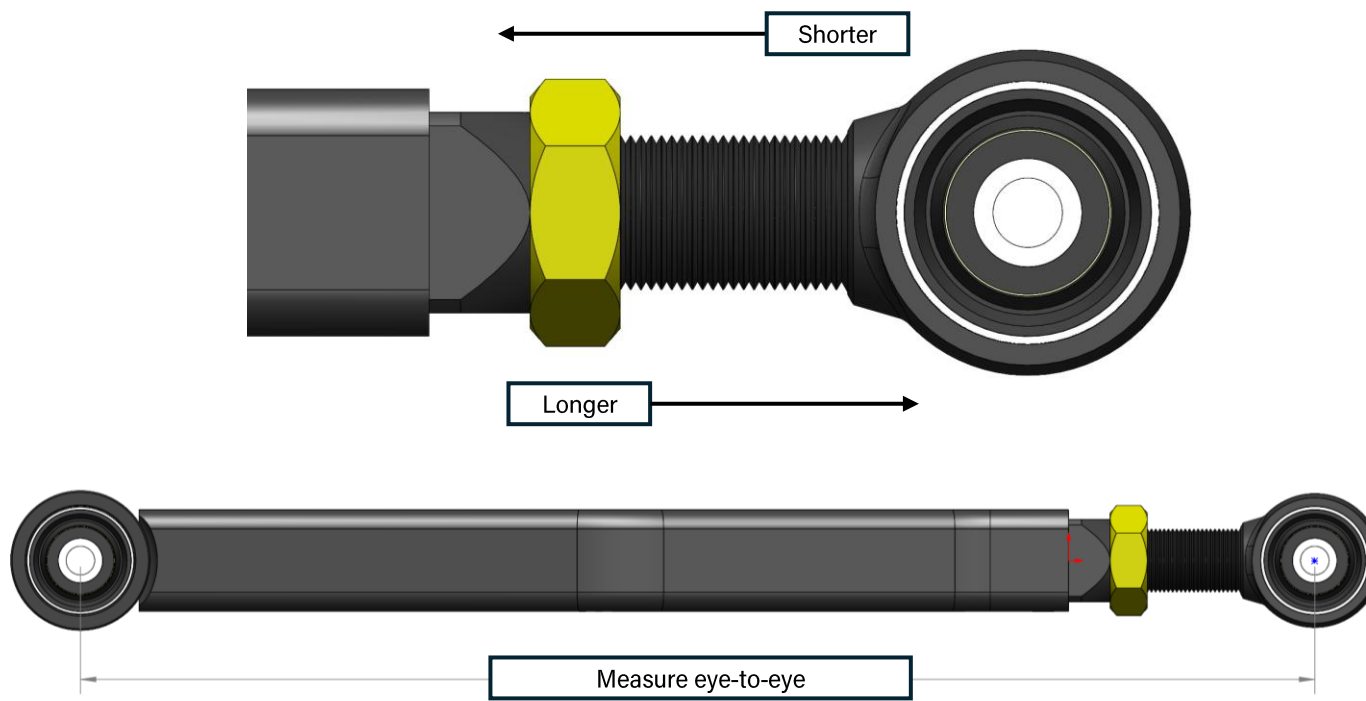

Figure 26: Rear shock top and bottom bolt installed loosely

INSTALLATION INSTRUCTIONS

26. Determine the appropriate length of the new control arms based on your vehicle's ride height and your desired pinion and caster angles. Use the lengths provided at the beginning of these instructions as a starting point or reference our **JT Suspension Quick Guide**. **For this lift kit, the rear uppers are round, and the rear lowers are square.**

Adjust the end-forging by screwing it in or out. **Measure the length from eye-to-eye, or center of bushing to center of bushing.** When the desired length is met, spin the jam nut down to the control arm to lock the forging into position.



INSTALLATION INSTRUCTIONS

27. Remove the rear lower control arms first. Complete one side at a time. Install the new lower control arms on both sides. The adjusters should be located on the frame side. **The lower arms are not side-specific, but they must be the same length.** See **our Control Arm Quick Guide for more information.** Do not torque yet.

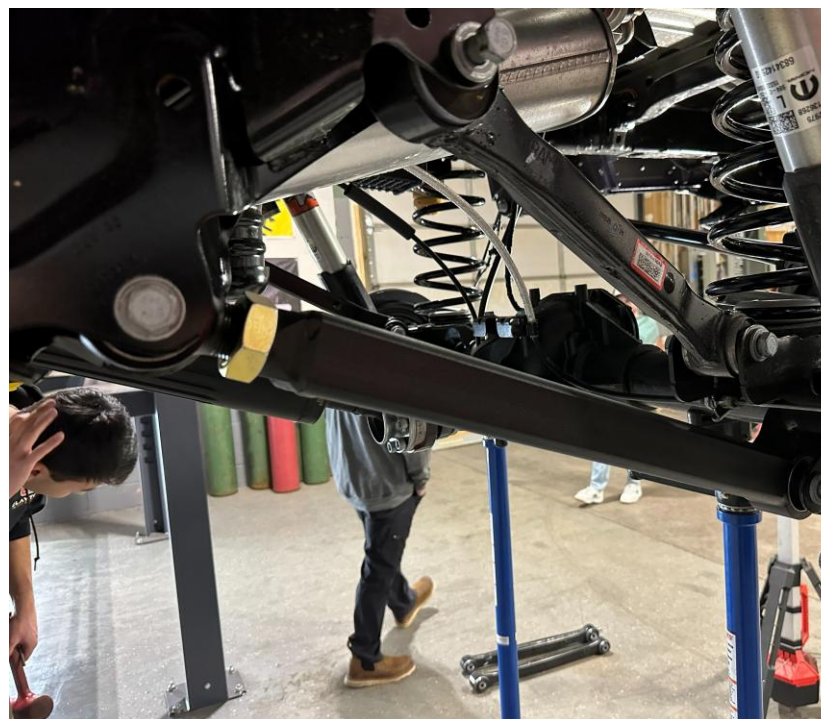

Figure 27: New driver-side control arms installed with original hardware

INSTALLATION INSTRUCTIONS

28. Remove the upper control arm on the driver side. **The passenger side upper arm will hold the pinion at its current angle. Ensure that the OEM passenger side upper arm is loosely installed.**

The vehicle will be returned to the ground (or a 4-post lift) at the end of the installation to dial in the caster angle and torque suspension bolts to specification. Only then should the passenger OEM rear upper control arm be removed, and the new Clayton rear upper control arms be installed (with the pinion supported)

If the new upper arms are forced into place, binding in the bushings can occur, potentially leading to a variety of issues. Wait until the end of these instructions to install the new upper arms and dial the caster angle.

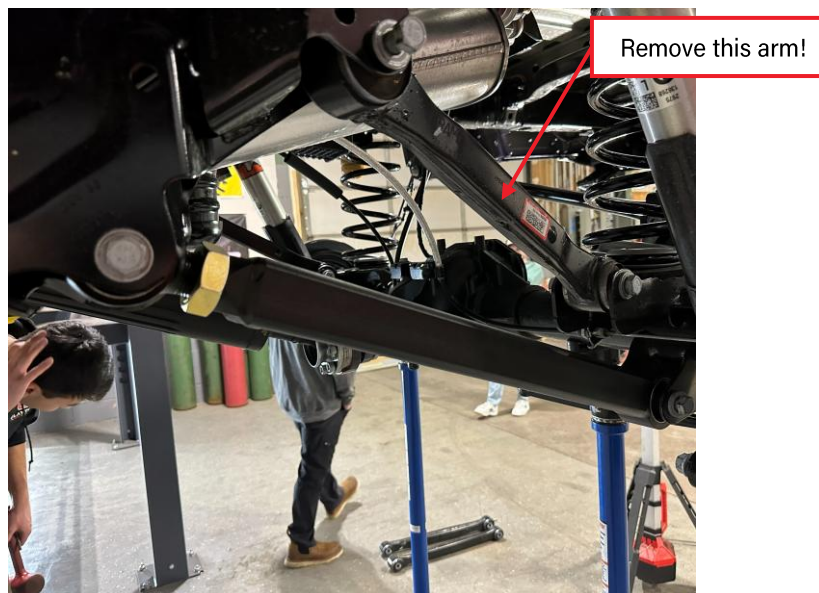

Figure 28: New control arms installed with original hardware

INSTALLATION INSTRUCTIONS

29. Cut the new rear sway bar rods to the recommended length at each end following the **Sway Bar Quick Guide**. You can find this quick guide on our website, or at the end of these instructions. Assemble the sway bar end-links and use a 6mm hex key and an 18mm wrench to install. **Do not torque yet.**

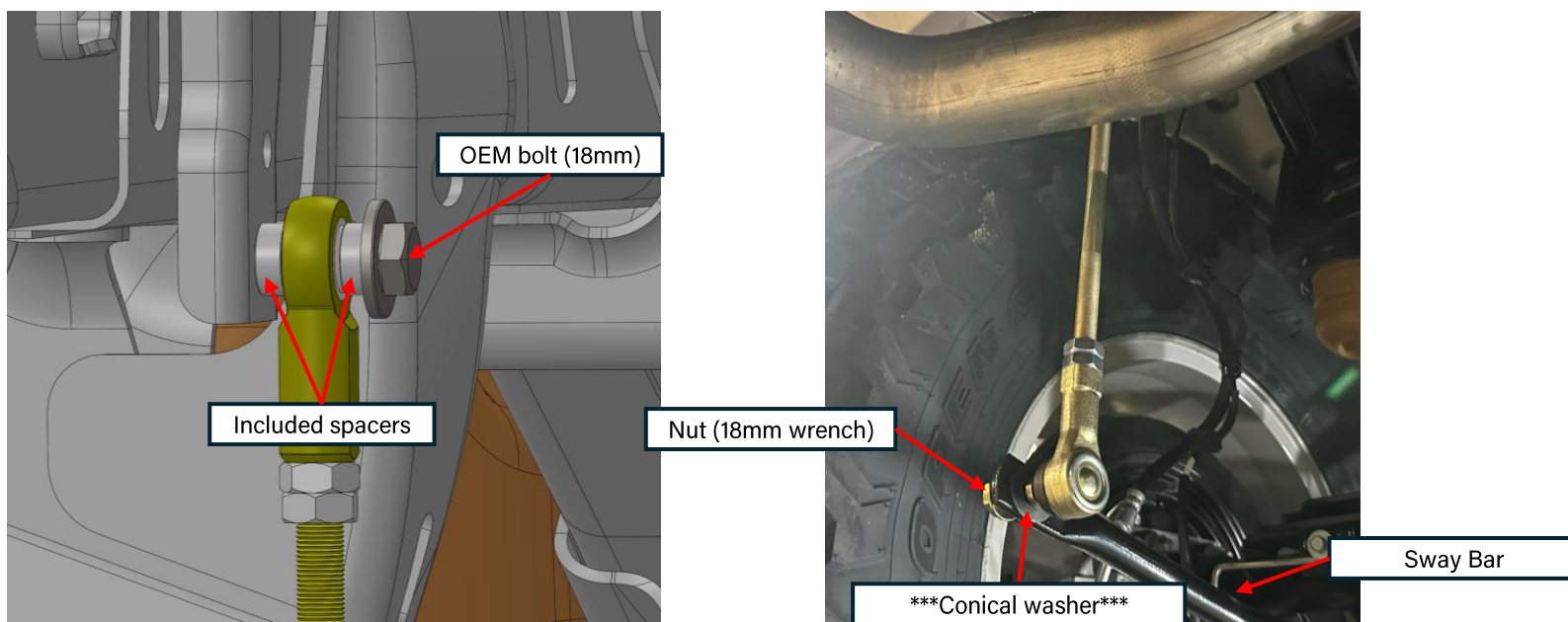

Figure 29: Sway bar end links installation process

*****Conical washers installed with the concave side facing towards the sway bar or tab, NOT the link!*****

INSTALLATION INSTRUCTIONS

30. Install the new rear track bar. Follow the **JT Suspension Quick Guide** for more information like starting lengths based on coil height. You can find this quick guide on our website under any JT lift kit listing, or at the end of these instructions. **Table 2 on Step 34 also has helpful starting lengths for the rear track bar.**

Do not torque yet. Install the axle bolt first, then the frame bolt using the original hardware.

Install the rear track bar with the hump in the bar over top of the rear differential. You may need a ratchet strap to align the hole on the frame side and recenter the axle.



Figure 30: New rear track bar installed

INSTALLATION INSTRUCTIONS

31. Install the rear bump stops. **Depending on lift height, you will install either the stackable 1" tall stops or the 3" tall stops.** You do not need to remove the coils to install the bump stops. You will want to articulate the vehicle to determine if you need more bump stop based off of lift height, tire size, and shock travel.

Our JT Bump Stops mount with hardware that uses a 1/4" hex key and a 1/2" wrench.



Figure 31: Bump-stops (1" tall and 3" tall bump-stop options)

TIP: If you find that you need more bump stop for your specific setup, consider our stackable bump stop extensions (COR-1410201), which are directly compatible with either bump stop shown above.

INSTALLATION INSTRUCTIONS

32. Reinstall the front/rear axle wiring harness and breather tube (if removed).

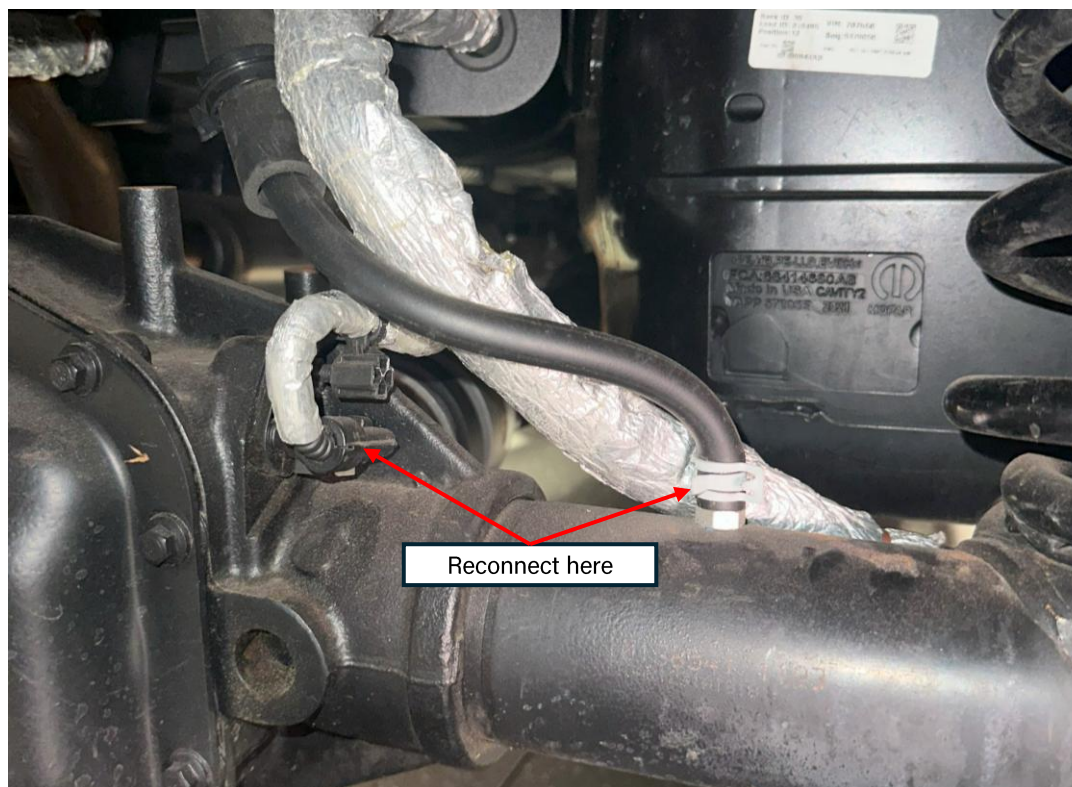

Figure 32: Differential wiring harness and breather tube reconnected

INSTALLATION INSTRUCTIONS

33. Reinstall the front cross-bar member using an 18mm socket. **Then, reinstall all four tires.**

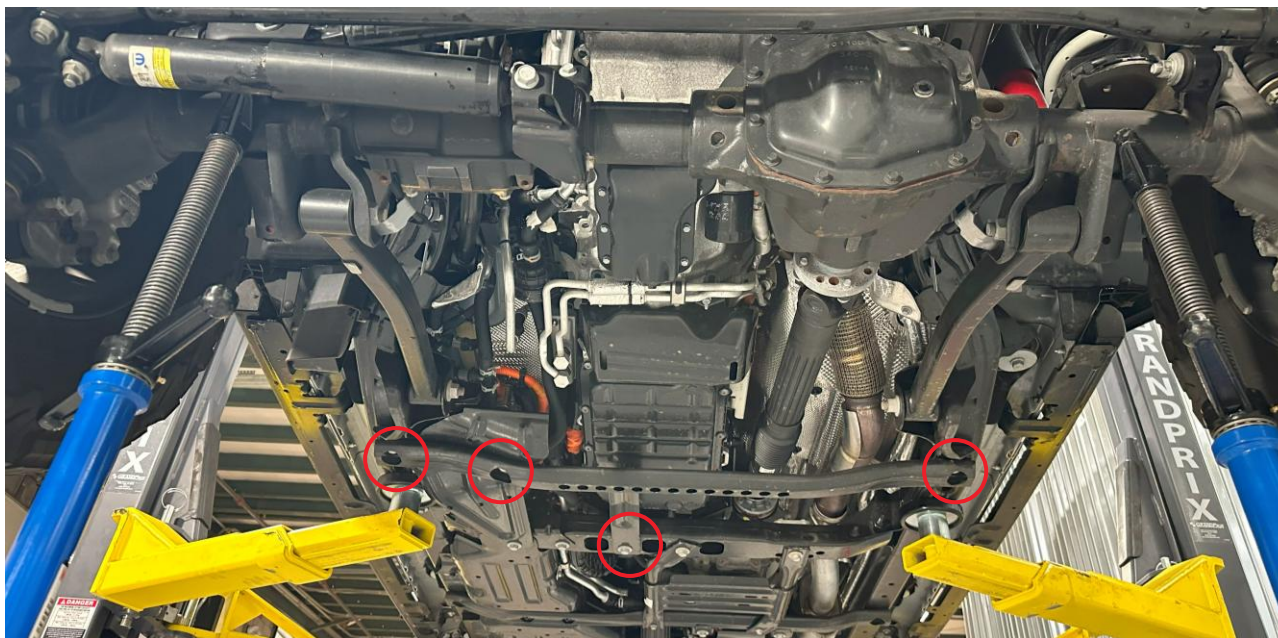

Figure 33: Engine guard skid plate/cross bar to be reinstalled

INSTALLATION INSTRUCTIONS

34. Refer to Table 2 for recommended front and rear track bar starting lengths applicable to this lift kit. The following lengths are recommendations and should only serve as a starting point for axle positioning. **The following measurements are given as "eye-to-eye" lengths.**

Table 2: COR Track Bar Length Specifications

Track Bar ID / Location	Minimum	1.5" Lift	2.5" Lift	3.5" Lift	4.5" Lift	Maximum
4509100 Front Track Bar	$33 \frac{9}{16}$ "	$33 \frac{15}{16}$ "	$34 \frac{1}{8}$ "	$34 \frac{1}{4}$ "	$34 \frac{3}{8}$ "	$35 \frac{3}{8}$ "
4510120 Rear Track Bar	$33 \frac{5}{8}$ "	$33 \frac{3}{4}$ "	$33 \frac{7}{8}$ "	34"	$34 \frac{3}{16}$ "	$35 \frac{1}{2}$ "



4509100 Front Track Bar



4510120 Rear Track Bar

INSTALLATION INSTRUCTIONS

35a. Lower the vehicle back to flat ground and let it settle under its own weight. Follow the following steps to install the remaining front upper control arms. Use OEM hardware and **DO NOT TIGHTEN.**

35b. Support the pinion to resist any movement. A bottle jack is perfect for this task. Adjust the jack so that there is just enough pressure to hold the pinion at its current angle. Then, **carefully remove the remaining OEM upper arm on the passenger side. Now, the only thing holding the pinion at its current angle is the bottle jack.**

35c. **The new front upper arms are side-specific.** Note which upper control arm installs on the driver side (It is marked with a red tag). Using the chart at the beginning of these instructions, set the driver's side upper arm to the recommended length based on your lift height. **Note that the recommended arm lengths will get you close to the desired 5-6 degrees of caster, but fine-tuning will be required.** Install the new arm following the OEM path.

35d. Install the remaining new front passenger upper arm. **The upper arms do not need to be the same length.** Adjust the new arm as needed to fit. **Do not force the arm to fit. This could create a bind in the other bushings. Do not tighten any bolts yet!**

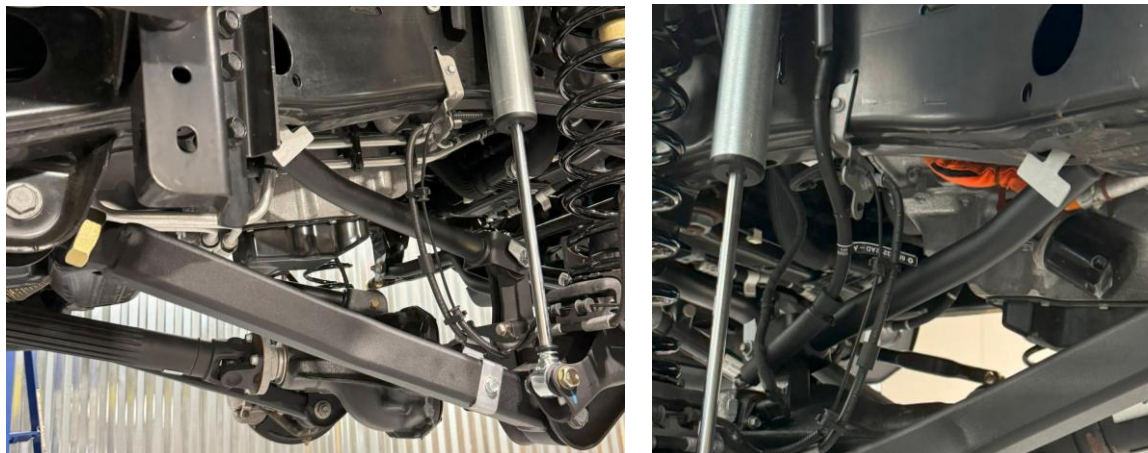

Figure 34: New front upper control arms loosely installed with original hardware

INSTALLATION INSTRUCTIONS

36a. Move back to the rear of the vehicle. With the vehicle still under its own weight, follow the following steps to install the remaining rear upper control arms. Use OEM hardware and **DO NOT TIGHTEN.**

36b. Support the pinion to resist any movement. A bottle jack is perfect for this task. Adjust the jack so that there is just enough pressure to hold the pinion at its current angle. Then, **carefully remove the remaining OEM upper arm on the passenger side. Now, the only thing holding the pinion at its current angle is the bottle jack.**

36c. **The new rear upper arms are NOT side-specific.** Using the chart at the beginning of these instructions, set the driver's side upper arm to the recommended length based on your lift height. **Note that the recommended arm lengths will bring the pinion close to the desired position, but fine-tuning will be required.** Install the new arm following the OEM path.

36d. Install the remaining new rear passenger upper arm. **The upper arms do not need to be the same length.** Adjust the new arm as needed to fit. **Do not force the arm to fit. This could create a bind in the other bushings. Do not tighten any bolts yet!**



Figure 35: New rear upper control arms loosely installed with original hardware

INSTALLATION INSTRUCTIONS

37. **With the vehicle still under its own weight**, torque the front and rear track bar bolts (axle and frame end). Refer to Table 3 below for recommended torque specifications of each bolt, as well as the wrench size.

Table 3: COR Track Bar Torque Specifications

Suspension Bolt Location	Wrench Size	Torque (lb-ft)
Front Track Bar Bolt, Frame Bolt	21mm	130
Front Track Bar Bolt, Axle Bolt	21mm	130
Rear Track Bar Bolt, Frame Bolt	21mm	90
Rear Track Bar Bolt, Axle Bolt	21mm	90

INSTALLATION INSTRUCTIONS

38. With the vehicle **still under its own weight**, verify the front and rear caster/pinion angles. Verify that the caster angle at the front axle falls between 5-6 degrees. For the rear pinion angle, verify that the axle falls between 5-6 degrees.

Because all vehicles are different, Clayton Off Road only provides recommended lengths for all adjustable arms and track bars. These values should only serve as starting points, as fine-tuning of these adjustments is required to dial in the vehicle's alignment and ride quality.

If your angles are out of specification of this range, remove the upper control arm bolts (one arm at a time) and spin the adjuster in or out. **Spin the upper arms equally, starting with 1-2 full rotations at a time.** Re-measure the angle after each adjustment to make sure you do not overshoot/undershoot the specified range.

You may take a baseline measurement at the top of the c-knuckle, or on the direct top of the ball joint (assuming the vehicle is parked on a flat surface). This measurement location should give you a good idea of what your current angles are; however, it is highly recommended that you visit an alignment shop to verify these angles and **then adjust accordingly.**

Finally, please note that the lower control arms should be adjusted to center the tires in the wheel well, also known as axle positioning. You will want to fully articulate the axles and check that there is no rubbing occurring on the inner fender liner. If rubbing occurs, bring the axle in or out by adjusting the lower control arms evenly.

INSTALLATION INSTRUCTIONS

39. Please refer to Table 4 below for helpful control arm torque specifications, as well as helpful wrench sizes.

NOTE: Some of Clayton Control Arms come with upgraded hardware. Table 4 displays the torque specification for **OEM** hardware. **Verify the bolt torque specification for any upgraded control arm hardware in the individual control arm instructions found on our website.**

Table 4: OEM Control Arm Hardware Torque Specifications

Suspension Bolt Location	Wrench Size	Torque (lb-ft)
Front Upper Control Arm, Frame Bolt (Factory Size)	18mm, 21mm	80
Front Upper Control Arm, Axle Bolt (Factory Size)	18mm	80
Front Lower Control Arm, Frame Bolt (Factory Size)	21mm, 24mm	180
Front Lower Control Arm, Axle Bolt (Factory Size)	21mm, 24mm	180
Rear Upper Control Arm, Frame Bolt (Factory Size)	21mm	180
Rear Upper Control Arm, Axle Bolt (Factory Size)	21mm	180
Rear Lower Control Arm, Frame Bolt (Factory Size)	21mm	180
Rear Lower Control Arm, Axle Bolt (Factory Size)	21mm	180

INSTALLATION INSTRUCTIONS

40. Refer to Table 5 below for helpful torque specifications related to the front and rear shocks.

NOTE: Some aftermarket shocks come with upgraded hardware. Table 5 displays the torque specification for **OEM** shock hardware. **Always verify the bolt torque specification for any upgraded hardware before torquing.**

Table 5: OEM Shock Torque Specifications

Suspension Bolt Location	Wrench Size	Torque (lb-ft)
Front Upper Shock Bolt, Frame Bolt	18mm	80
Front Lower Shock Bolt, Axle Bolt	18mm	75
Rear Upper Shock Bolt, Frame Bolt	18mm	80
Rear Lower Shock Bolt, Axle Bolt	18mm	75

NOTE: Mojave models will have upgraded shock hardware. Wrench size may vary.

INSTALLATION INSTRUCTIONS

41. Refer to Table 6 below for helpful torque specifications related to the sway bar end links, as well as jam nuts at the track bars and track bars.

Table 6: COR Sway Bar End Link and Jam Nut Torque Specifications

Suspension Bolt Location	Wrench Size	Torque (lb-ft)
Sway Bar End-Link Nuts	18mm	100
Sway Bar Jam Nuts	3/4"	64
Lower Control Arm Adjuster Jam Nuts	1-7/8"	Very Tight
Upper Control Arm Adjuster Jam Nuts	1-1/2"	Very Tight
Track Bar Jam Nuts	1-1/2"	Very Tight

SWAY BAR QUICK GUIDE

Please review the following information so you can become familiar with our sway bar products

Continue to the next page for important installation notes

Jam Nuts (3/4") x8

Connecting Rod x2

★ 2024+ Rubicon ONLY Inserts x2
AMP-HDW-H502C

★ 2024+ non-Rubicon Inserts x2
AMP-HDW-H502B

Heim Joint x1

Heim Joint Spacers x2

End Links x3
Sway Bar Nuts (18mm) x3

Conical Washers x3

★ 2024+ Rubicon models with the solid version of the sway bar will need to utilize bushing inserts PN-AMP-HDW-H502C, which are inserted directly into the factory sway bar as shown on the next page

★ 2024+ non-Rubicon models with the hollow sway bar will need to utilize bushing inserts PN-AMP-HDW-H502B, which are inserted directly into the factory sway bar as shown on the next page

Bushing inserts are NOT necessary on 2018-2023 models

SWAY BAR QUICK GUIDE

NOTE: Jeep Gladiator (JT) and Jeep Wrangler (JL) Front Sway Bar End Links are intended to come with **three** studded rod ends and **one** single Heim Joint (as pictured on the previous page).

- **The single Heim Joint is to be used on the passenger side at the axle (bottom) for proper clearance with the factory double-shear bracket, meaning no additional modifications are necessary.**

NOTE: Conical washers provide an even greater surface area through beveled sides, distributing the force of the tightening nut while reducing vibrations and preventing the nut from coming loose.

- **Conical washers should be used on all models and years, with the concave side curving inward towards the sway bar.**

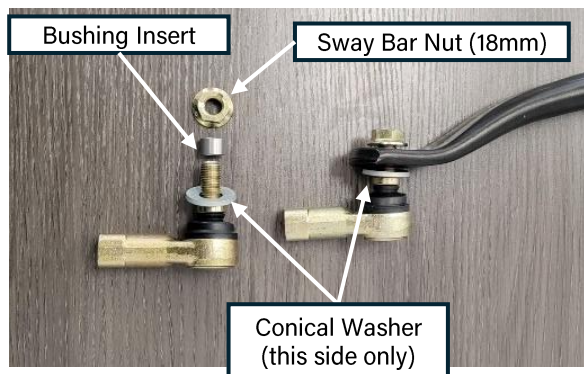

Lift Height	Stock	1.5" Lift		2.5" Lift		3.5" Lift		4.5" Lift	
Component		Center Length	Cut Each End	Center Length	Cut Each End	Center Length	Cut Each End	Center Length	Cut Each End
JK Front Sway Bar Link	5.250	8-1/4"	3-7/16"	9-1/4"	2-15/16"	10-1/4"	2-7/16"	11-1/4"	1-15/16"
JK Rear Sway Bar Link	8.750	10-3/4"	2-3/16"	11-3/4"	1-5/8"	12-3/4"	1-3/16"	13-3/4"	5/8"
JL Front Sway Bar Link	5.063	8-1/4"	3-7/16"	9-1/4"	2-15/16"	10-1/4"	2-7/16"	11-1/4"	1-15/16"
JL Rear Sway Bar Link	8.750	10-3/4"	2-3/16"	11-3/4"	1-5/8"	12-3/4"	1-3/16"	13-3/4"	5/8"
JT Front Sway Bar Link	5.063	8-1/4"	3-7/16"	9-1/4"	2-15/16"	10-1/4"	2-7/16"	11-1/4"	1-15/16"
JT Rear Sway Bar Link	10.625	12-5/8"	1-1/4"	13-5/8"	3/4"	14-5/8"	1/4"	15-5/8"	0"

Our newly improved end link design allows the installer to hold the stud with either a 6mm hex key or a 14mm wrench to tighten the nut. Either option works, as long as the sway bar end link nut is torqued to **90-100 ft-lbs**

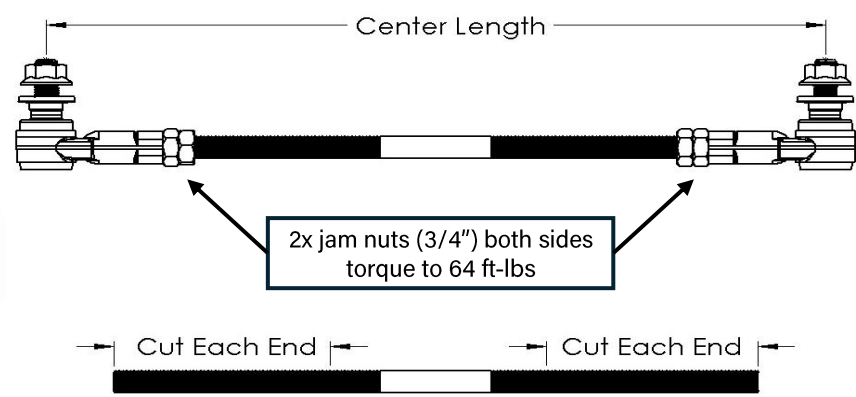
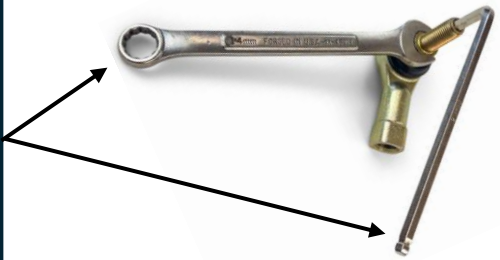

INSTALLATION INSTRUCTIONS

42. Tighten down the jam nuts on the upper and lower control arms. Use a 1-7/8" wrench for the lower control arm jam nuts, and a 1-1/2" wrench for the upper control arm jam nuts and track bars. Use a breaker bar to gain additional leverage. Tighten all jam nuts down as tight as humanly possible.

Please note that not all wrenches are created with the same tolerances. If your wrenches are too loose around the jam nut, Clayton Off Road offers tight, wrap-around wrenches for purchase. Please search for the wrenches using the SKU's below.



Figure 36: COR Wrench-ends for control arm jam nuts and track bars (COR-2500125, COR-2500100)

INSTALLATION INSTRUCTIONS

43. **3.5" Lift Kits Note:** Clayton Off Road includes extended rear brake lines with Gladiator 3.5" lift kits. It is recommended that the brake lines be installed at the end of the installation when all the suspension work is completed. Please refer to the specific brake line instructions COR-1310102 (which can be found on our website under the product page) for a more step-by-step guide.

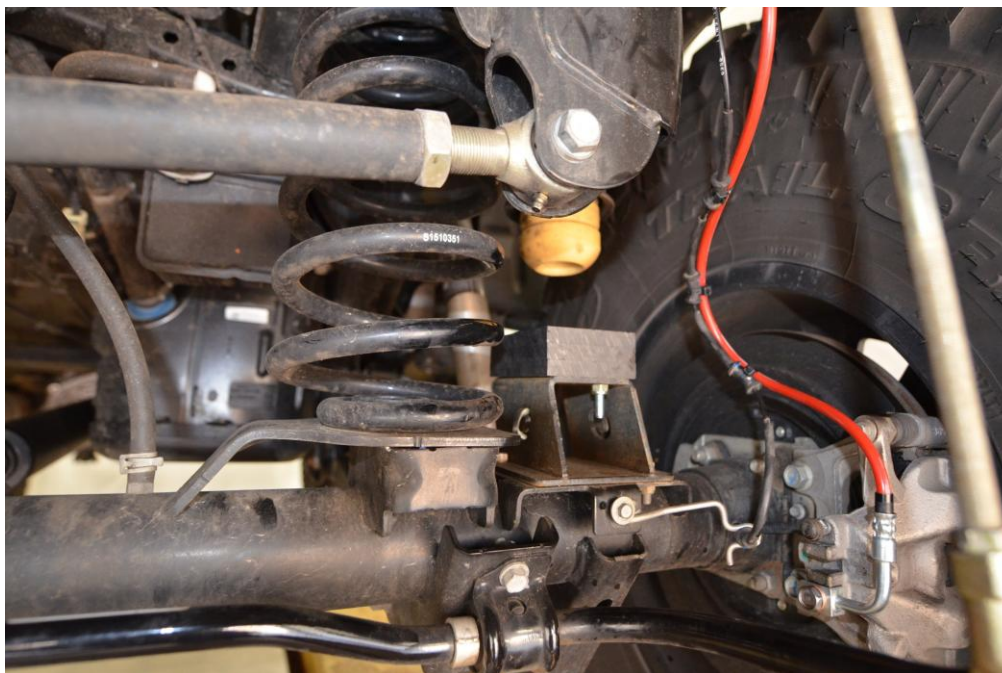

Figure 37: Rear Gladiator Extended Brake Lines installed

INSTALLATION INSTRUCTIONS

44. Congratulations, you've completed our Short Arm Lift Kit Installation. Please see the post-installation checklist and confirm you have completed all of the steps before driving your vehicle.



POST-INSTALLATION CHECKLIST:

- Differential sensors/hoses (front and rear) are plugged back in
- Brake lines are put back into place and not damaged or stretched
- Crash bracket is reinstalled on both sides of the vehicle
- Caster set somewhere between 5-6 degrees
- Axles properly centered in wheel-well (axle track and position)
- All hardware is torqued to specification (Refer to Tables 3-6)
- Control arm and track bar jam nuts are as tight as possible
- Sway bar end links are the proper length and tightened to specification
- Lug nuts are torqued to the manufacturer's specification
- A licensed shop has professionally aligned the vehicle
- Retorque all hardware after 500 miles of driving

