

INSTALLATION MANUAL:

Jeep Wrangler Diesel Ride Right+ Lift Kits (2021+, JL)
All Lift Heights

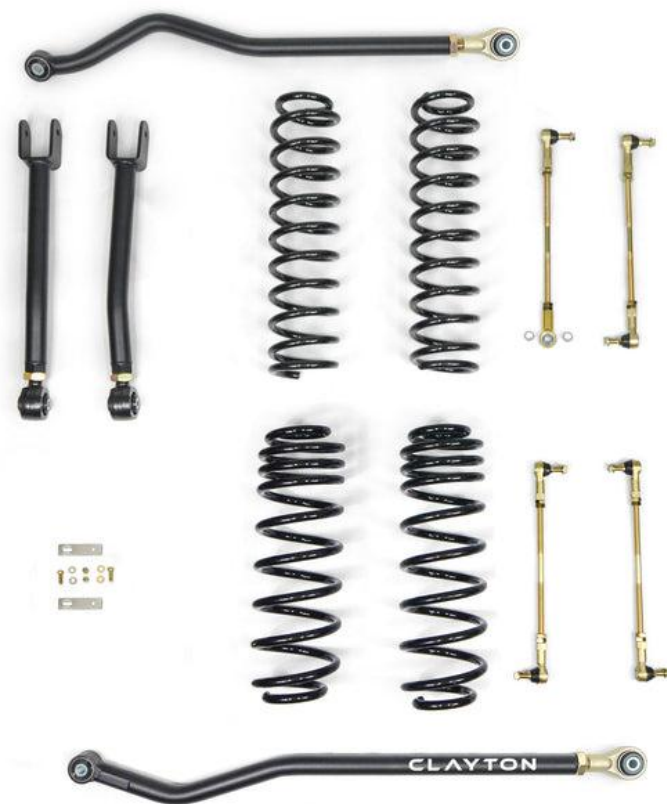

LIFT KIT OVERVIEW - 3109515

Please review the following item list for your purchased kit so you can become familiar with the included items

3109515 Jeep Wrangler Diesel Ride Right+ 1.5" Lift Kit (2018+, JL)	
SKU	Description
1508250	Jeep Wrangler 1.5" Front Coil Springs (2020-2023 JL-V6 DIESEL)
1509151	Jeep Wrangler 1.5" Dual Rate Rear Coil Springs (2018+, JL)
5109100	Jeep Wrangler Adjustable Sway Bar End Links (2018+, JL)
5109110	Jeep Wrangler Adjustable Sway Bar End Links (2007+, JK/JL)
1709101	Jeep Wrangler Overland+ Short Front Upper Control Arms (2018+, JL)
4509100	Jeep Wrangler Adjustable Front Track Bar (2018+, JL)
4509110	Jeep Wrangler Adjustable Rear Track Bar (2018+, JL)

The following document provides general, basic instructions for the items listed above. Please navigate to a specific product page on our website for more in-depth instructions if you require a more specific, step-by-step guide

LIFT KIT OVERVIEW - 3109525

Please review the following item list for your purchased kit so you can become familiar with the included items

3109525 Jeep Wrangler Diesel Ride Right+ 2.5" Lift Kit (2018+, JL)	
SKU	Description
1508350	Jeep Wrangler 2.5" Front Coil Springs (2020-2023 JL-V6 DIESEL)
1509251	Jeep Wrangler 2.5" Dual Rate Rear Coil Springs (2018+, JL)
5109100	Jeep Wrangler Adjustable Sway Bar End Links (2018+, JL)
5109110	Jeep Wrangler Adjustable Sway Bar End Links (2007+, JK/JL)
1709101	Jeep Wrangler Overland+ Short Front Upper Control Arms (2018+, JL)
4509100	Jeep Wrangler Adjustable Front Track Bar (2018+, JL)
4509110	Jeep Wrangler Adjustable Rear Track Bar (2018+, JL)

The following document provides general, basic instructions for the items listed above. Please navigate to a specific product page on our website for more in-depth instructions if you require a more specific, step-by-step guide

LIFT KIT OVERVIEW - 3109535

Please review the following item list for your purchased kit so you can become familiar with the included items

3109535 Jeep Wrangler Diesel Ride Right+ 3.5" Lift Kit (2018+, JL)	
SKU	Description
1508450	Jeep Wrangler 3.5" Front Coil Springs (2020-2023 JL-V6 DIESEL)
1509351	Jeep Wrangler 3.5" Dual Rate Rear Coil Springs (2018+, JL)
5109100	Jeep Wrangler Adjustable Sway Bar End Links (2018+, JL)
5109110	Jeep Wrangler Adjustable Sway Bar End Links (2007+, JK/JL)
1709101	Jeep Wrangler Overland+ Short Front Upper Control Arms (2018+, JL)
4509100	Jeep Wrangler Adjustable Front Track Bar (2018+, JL)
4509110	Jeep Wrangler Adjustable Rear Track Bar (2018+, JL)
1309501	Jeep Wrangler Stainless Steel Front Brake Line Bracket Extensions (2018+, JL)

The following document provides general, basic instructions for the items listed above. Please navigate to a specific product page on our website for more in-depth instructions if you require a more specific, step-by-step guide

DISCLAIMER

WARNING:

Suspension systems and their components are designed to enhance your vehicle's off-road performance. This may cause your vehicle to handle differently, on and off-road. Always wear your seatbelt and take extra care when driving a modified vehicle. Failure to do so can result in loss of control which may result in a rollover causing serious injury, or even death to the driver and/or passengers of the vehicle. Regular maintenance and consistent inspections are required to keep your modified vehicle safe and functioning properly. These suspension systems and any components should be installed by certified technicians only. Attempts to install these products without proper knowledge can lead to poor performance, or possible failure, which may jeopardize the safety of the vehicle and its passengers. The installer is responsible for proper installation ensuring a safe and properly functioning vehicle. Take extra care when operating a modified vehicle and thoroughly inspect your vehicle before and after every off-road use.

Read the instruction set in its entirety before attempting the installation.

NOTE:

This product may require general welding, fabrication, and automotive mechanic skills. Welding should only be done by a competent welder. Clayton Off Road implies no guarantees or warranties and is not liable for improper installation. Some grinding and fitment may be required when installing this product. Every vehicle varies slightly, and some fabrication and/or modification may be required.

ATTENTION:

It is the customer's responsibility to thoroughly inspect all received parts to ensure they are assembled correctly and fully welded. Please carefully examine all weld seams and verify that bolt-through holes are properly aligned. Some Clayton Off Road products are permanent, non-removable, weld-on solutions. **If a defect or issue is found after installation, especially with permanent weld-on components, it may be difficult or impossible to correct.** Inspecting the part(s) received beforehand helps prevent unnecessary and avoidable complications.

ATTENTION: TORQUE SPECIFICATION

When working on any vehicle, it is good practice to torque suspension/weight-bearing components while the vehicle is resting under its load. This instruction set, as well as any other Clayton Off Road instruction set, assumes the installer will tighten any suspension-related components properly, to the recommended torque specification, when the vehicle is resting safely under its own weight.

CONTROL ARM OVERVIEW

Please review the following information so you can become familiar with our purchasable options



OVERLAND PLUS

Designed for the daily driver/weekend warrior. Features dual-durometer, maintenance-free bushings for comfort on-road and capability on the trails. One of our two available suspension systems that utilize a unique mid-arm design for perfecting suspension geometry. Fully adjustable, 100% bolt on, and Made-In-The-USA with a Lifetime Warranty.



PREMIUM SERIES

Designed for the off-road enthusiast. Features both maintenance-free bushings and forged Johnny Joint adjusters for maximum versatility and flex. One of our two available suspension systems that utilize a unique mid-arm design for perfecting suspension geometry. Fully adjustable, 100% bolt on, and Made-In-The-USA with a Lifetime Warranty.

Currently, all Right-Right+ Kits ONLY come with our dual-durometer, maintenance-free Giiro Joint bushings

CONTROL ARM LENGTHS

Please refer to the table below for minimum, maximum, and recommended control arm lengths. These lengths are recommendations and should only serve as a starting point for axle positioning and dialing in pinion/caster angle. **The following measurements are given as "eye-to-eye" lengths (center-to-center of joints). The desired caster angle should be somewhere between 4.5 - 6 degrees.** These are **NOT** intended as final measurements. Due to many variables, final adjustments should be made once all components are installed, then fine-tuned for your specific vehicle.

Table 1: COR Control Arm Length Specifications

Control Arm Type / Series	Minimum	1.5" Lift	2.5" Lift	3.5" Lift	4.5" Lift	Maximum
1709101 Jeep Overland+ Short Front Upper Arms	$19 - \frac{3}{4}$ "	$20 - \frac{3}{16}$ "	$20 - \frac{1}{4}$ "	$20 - \frac{3}{8}$ "	$20 - \frac{9}{16}$ "	$21 - \frac{1}{8}$ "

FRONT-END INSTALLATION

The following instructions are a generic guide to installing the front-end components. Please navigate to a specific product page for more in-depth instructions if you require a more specific, step-by-step guide



INSTALLATION INSTRUCTIONS

Take this product to a licensed professional if you are hesitant about the installation process!

The following instructions apply to the listed components below:

- Front Coil Springs (1.5", 2.5", 3.5")
- Front Adjustable Track Bar
- Front Upper Control Arms (Overland+)
- Front Sway Bar End Links
- Brake Line Extension Bracket

The following instructions provide a basic guide for installing the front-end components for the mid-arm lift kit!

If you purchased items separately or swapped in other components, your installation process will vary.

We strongly recommend having basic mechanic's hand tools, sockets, wrenches, vehicle jacks and stands, and other common tools readily available. Installing an aftermarket lift kit is a detailed process, and having the right tools on hand will ensure a smoother installation.

As always, feel free to contact us at any point during your installation - you can count on us to help!

INSTALLATION INSTRUCTIONS

TOOLS REQUIRED FOR INSTALLATION

- *Basic hand tools*
- *Hex key set*
- *Metric wrench/socket set*
- *Standard wrench/socket set*
- *Large box wrench (Large adjustable OR 1-1/2")*
- *Adjustable wrench*
- *Torque wrench*
- *Jack stands and/or vehicle lift*

1. Position the vehicle either on the ground or on a lift. For this installation, it is recommended that the vehicle be supported by the frame. Support the front axle with two additional jack stands. Remove the front tires and set aside.



Figure 1: Vehicle supported by lift and jack stands

*****Photos of control arm adjusters in the following photos may not match your selected series, but the installation remains the same!*****

INSTALLATION INSTRUCTIONS

2. Remove the factory front sway bar end-links. The socket size may vary depending on which vehicle, year, or aftermarket components you may already have installed. **Use an 18mm socket/wrench if OEM.** Put the passenger axle hardware aside and tuck the sway bar up and out of the way.

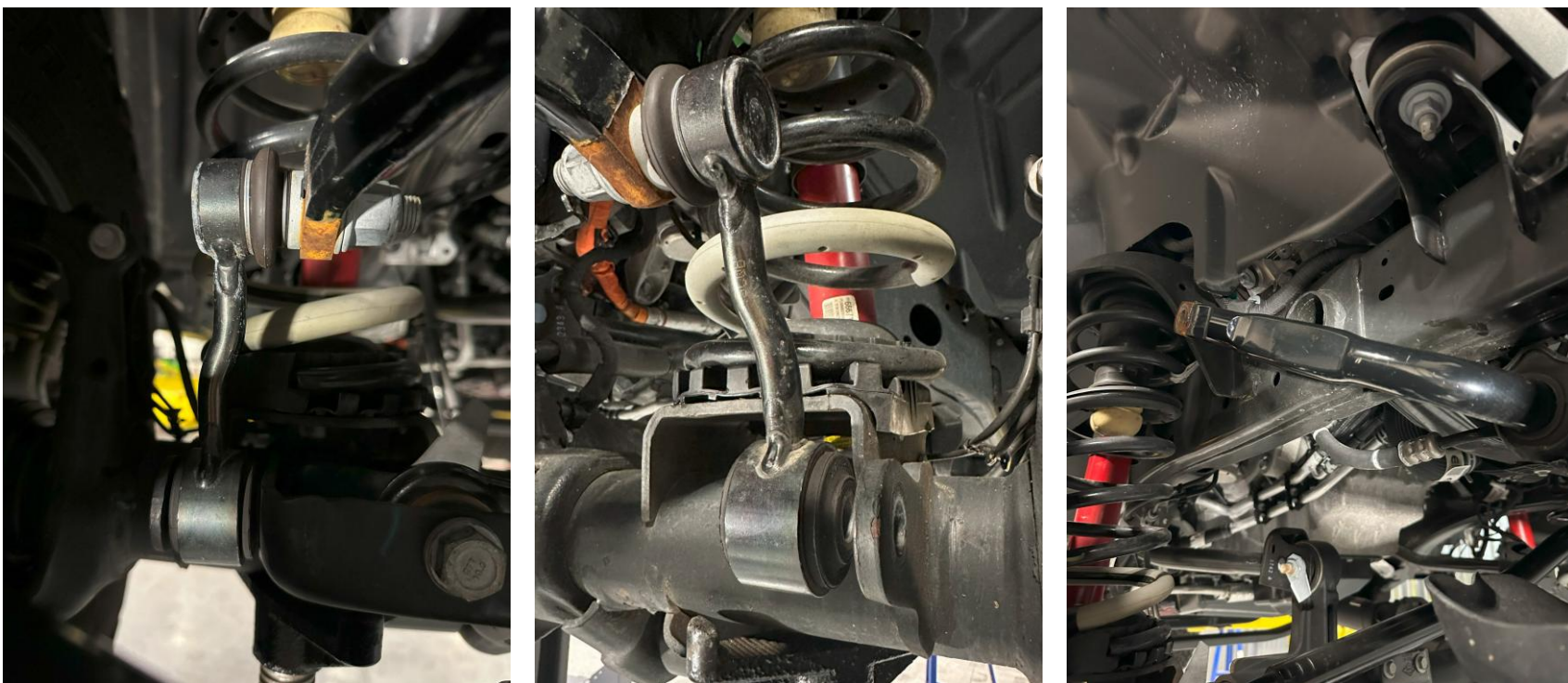

Figure 2: Front passenger and driver-side sway bar end link to be removed, with sway bar tucked up and away

INSTALLATION INSTRUCTIONS

3. Remove the lower shock bolts using an 18mm socket. Save the hardware and put it aside. Move to the top of the shocks and remove the top shock bolts with an 18mm socket. It may be hard to get to, so push the fender liner out of the way and use a socket extension. You may need to notch or cut the fender liner with a knife/blade to obtain enough clearance. Remove the shocks completely and put them aside.



Figure 3: Front driver/passenger lower shock bolts removed



Figure 4: Front upper passenger shock bolt removed

INSTALLATION INSTRUCTIONS

4. Remove the brake line bracket off the front lower control arms using a 15mm socket and let the bracket hang. Then, remove the front upper control arm heat shields from both sides. Two, 10mm bolts retain each heat shield. One bolt is located on the side, the other on the top (hidden). The top bolt is hard to get to, so use a small ratchet or ratcheting socket.



Figure 5: Front driver/passenger lower brake line mount removed

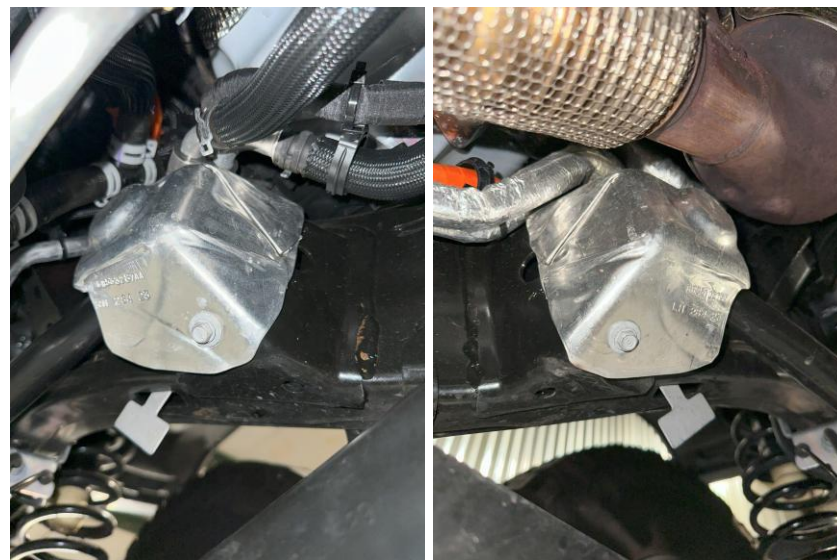

Figure 6: Front upper control arm heat shields to be removed

NOTE: You can cut off the control arm heat shields if you cannot reach the top 10mm bolt, as the shield will not be reused.

TIP: Remove the upper brake line bracket from the frame to ensure that the brake lines do not strain when the axle is lowered. You may also remove all the christmas-tree plastic clips that retain the ABS cable.

INSTALLATION INSTRUCTIONS

5. Remove the front factory track bar. Start with the frame bracket bolt (21mm) and then the axle bolt (21mm).

Unplug the differential sensor, and remove the breather tube. Also, remove the plastic push-clip from the upper factory control arm. Put the hardware aside, as it will be reused.



Figure 7: Front factory track bar bolts locations (left) and wiring harness/breather hose and plastic clips (right)

INSTALLATION INSTRUCTIONS

6. Loosen the control arm bolts in the front end, **but do not remove them**. You will need 18mm, 21mm, and 24mm sockets. **Make sure that the axle remains supported. Try to minimize any axle shift that may occur during this process.**



Figure 8: Lower/upper frame-side control arm bolts, and lower/upper axle-side control arm bolts

INSTALLATION INSTRUCTIONS

7. Droop the axle by lowering the supporting jack stands (or raising the vehicle) and remove the factory springs. **Retain the spring isolator, as it will be reused.**



Figure 9: Axle drooped with old springs removed

INSTALLATION INSTRUCTIONS

8. Install the new front springs. **The last two digits etched on the front coils should read xxxxx50.** The front coils for this kit are **NOT** side-specific. Install the new springs while the axle is still dropped. Make sure that the springs are set properly on the coil perch and are retained in the upper spring mount. **Ensure the spring isolator is installed at this time.**

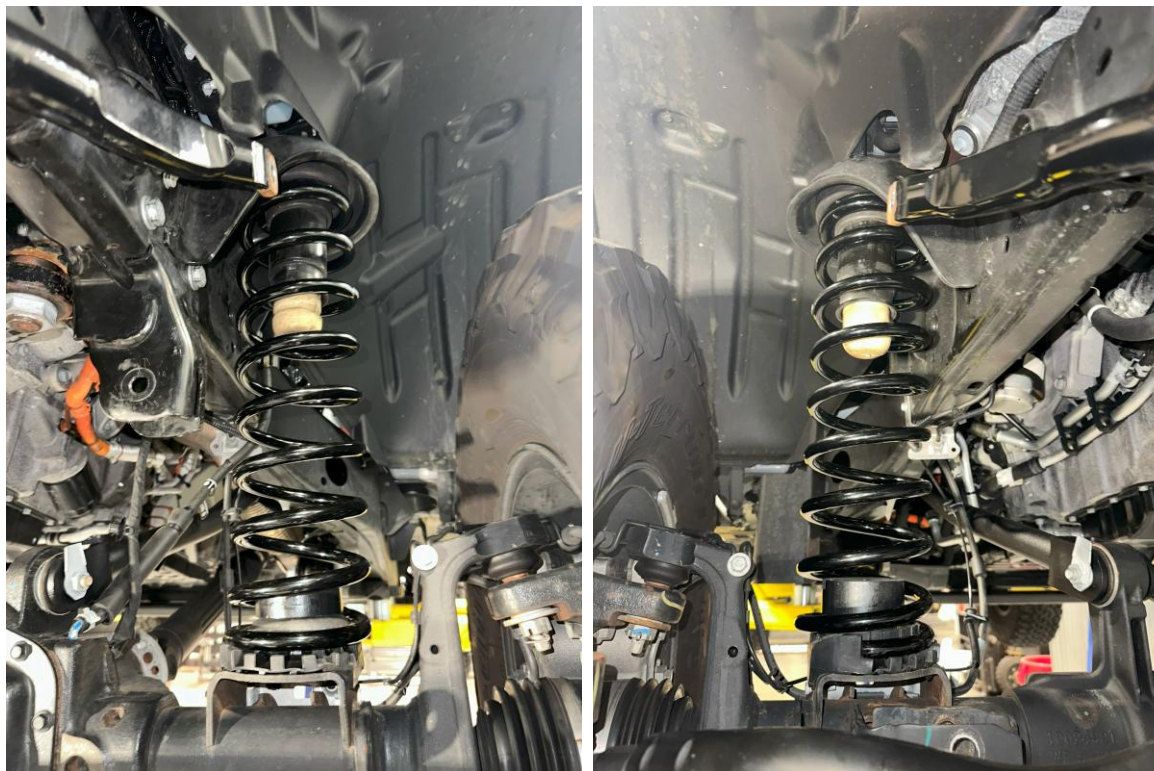

Figure 10: New springs installed and seated properly

*****Ride Right+ Kits do not come with new bump stops, but if you purchased them separately, you may install them now*****

INSTALLATION INSTRUCTIONS

9. Re-install the front shocks or install new shocks. Install the upper bolt first, then the lower axle bolt. Use original hardware, unless your new shocks came with new hardware. If the aftermarket shocks came with a piggyback reservoir, install them at this time. **Do not torque yet.**

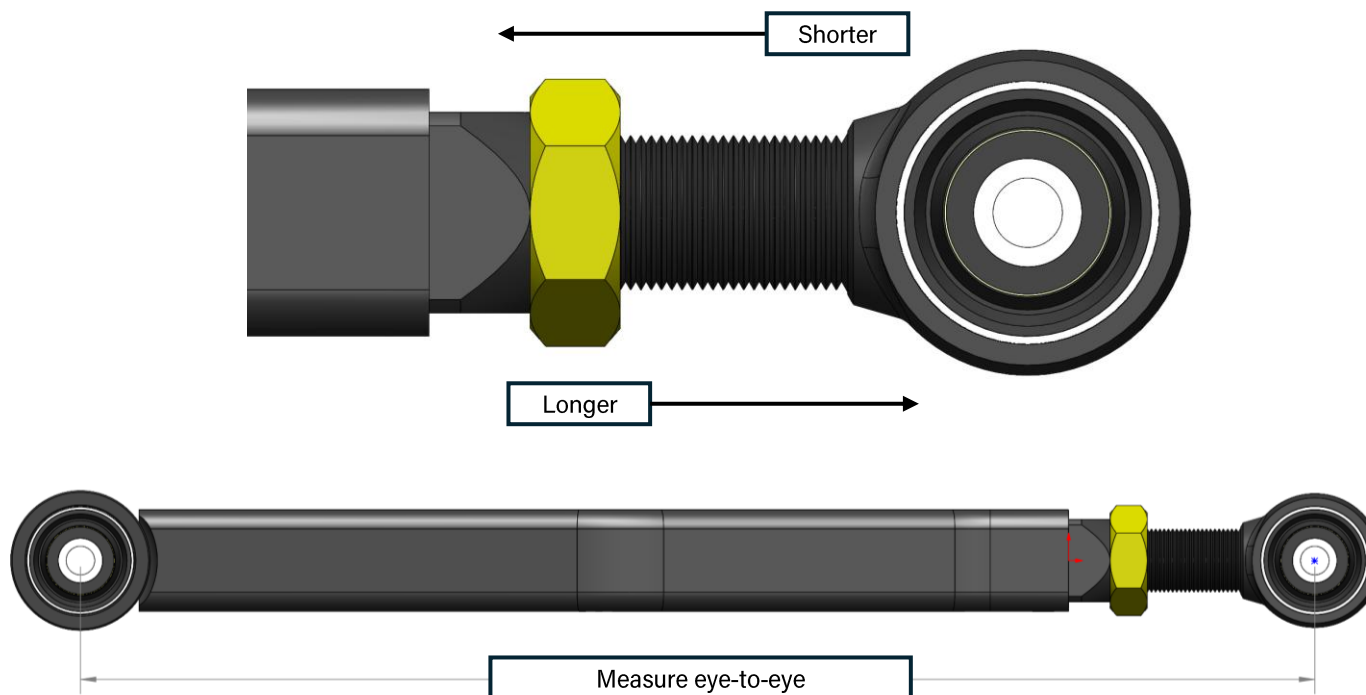

Figure 11: Front shock top and bottom bolt installed loosely

INSTALLATION INSTRUCTIONS

10. Determine the appropriate length of the new control arms based on your vehicle's ride height and your desired pinion and caster angles. Use the lengths provided at the beginning of these instructions as a starting point or reference our **JL Suspension Quick Guide**.

Adjust the end-forging by screwing it in or out. **Measure the length from eye-to-eye, or center of bushing to center of bushing.** When the desired length is met, spin the jam nut down to the control arm to lock the forging into position.



INSTALLATION INSTRUCTIONS

11. Remove the upper control arms **on the driver-side first. The upper arms ARE side-specific.** When installed properly, the bends in the arms should be pointing downward and in, away from the frame of the vehicle. **See our Control Arm Quick Guide for more information. Do not torque yet.**



Figure 12: New driver-side upper control arm installed with original hardware

INSTALLATION INSTRUCTIONS

12. Remove the upper control arm **on the passenger side. The upper arms ARE side-specific.** When installed properly, the bends in the arms should be pointing downward and in, away from the frame of the vehicle. **See our Control Arm Quick Guide for more information. Do not torque yet.**

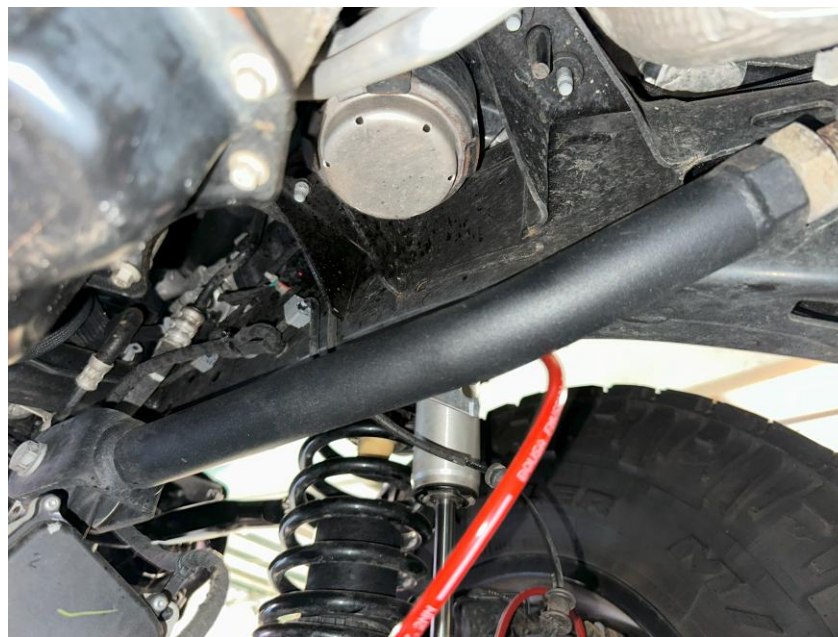

Figure 13: New passenger-side upper control arm installed with original hardware

INSTALLATION INSTRUCTIONS

13. Reattach the brake line brackets and all of the plastic christmas-tree clips. Reattach the frame-mount for the brake line on both sides using the original hardware.

For lift kits with 3.5"+, please use the supplied brake line extension bracket as seen in the photo on the right.



Figure 14: Brake line brackets reinstalled

INSTALLATION INSTRUCTIONS

14. Install the new front track bar. Follow the **JL Suspension Quick Guide** for more information such as starting lengths based on coil height. You can find this quick guide on our website under any JL lift kit listing, or details at the end of these instructions.

Do not torque yet. Install the axle bolt first, then the frame bolt using the original hardware.

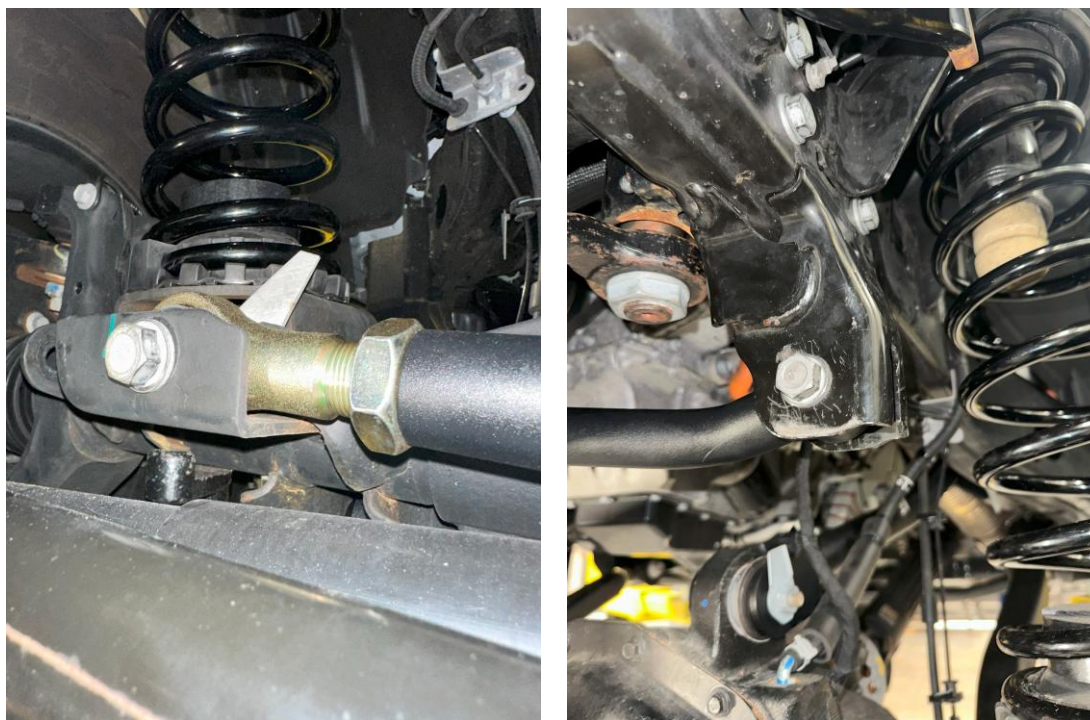

Figure 15: New front track bar installed

INSTALLATION INSTRUCTIONS

15. Cut the new sway bar rods to the recommended length at each end following the **Sway Bar Quick Guide**. You can find this quick guide on our website, or details at the end of these instructions. Assemble the sway bar end-links and use a 6mm hex key and an 18mm wrench to install. Reuse the factory bolt for the passenger axle-side connection with the Heim joint.

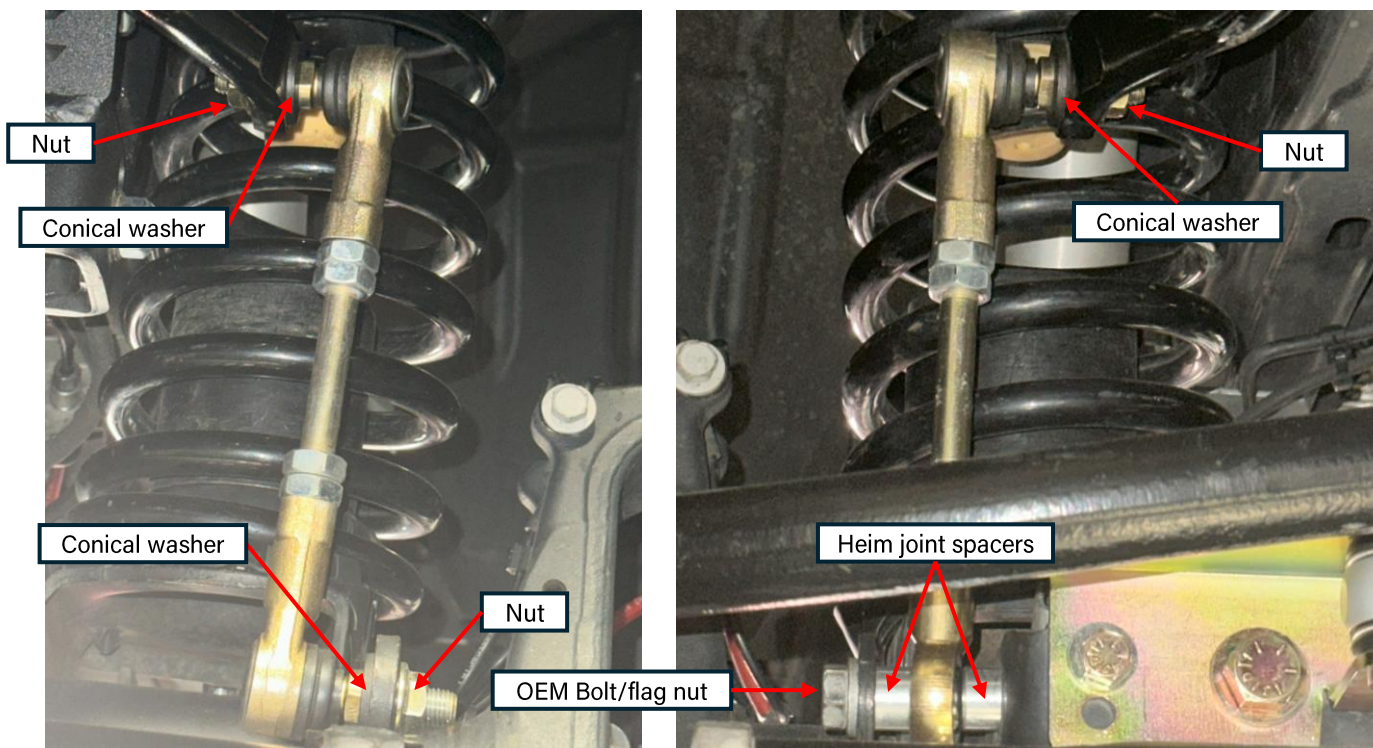

Figure 16: Front driver-side and passenger-side sway bar end link proper orientation

*****Conical washers installed with the concave side facing towards the sway bar, NOT the link!*****

INSTALLATION INSTRUCTIONS

16. Reinstall the front axle wiring harness and breather hose. Use pliers to pinch the hose clip and slip the hose over the stem.

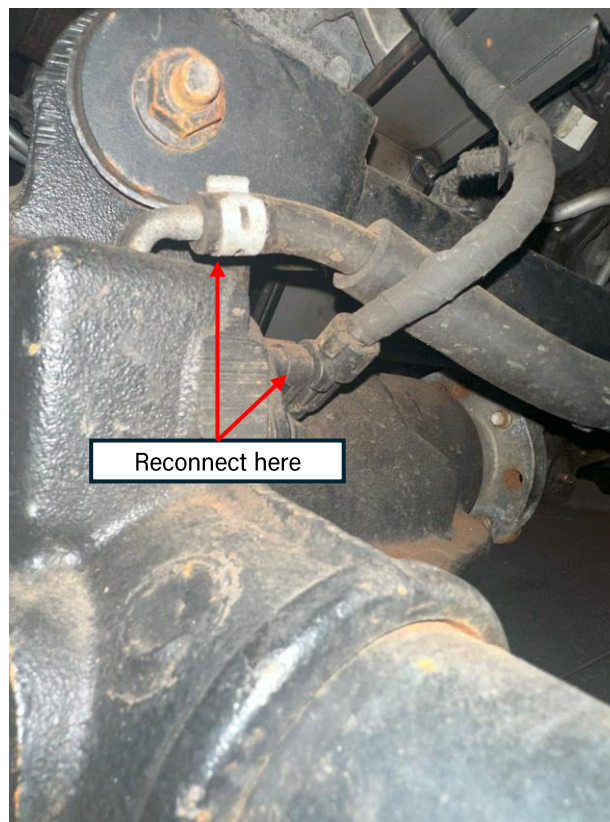
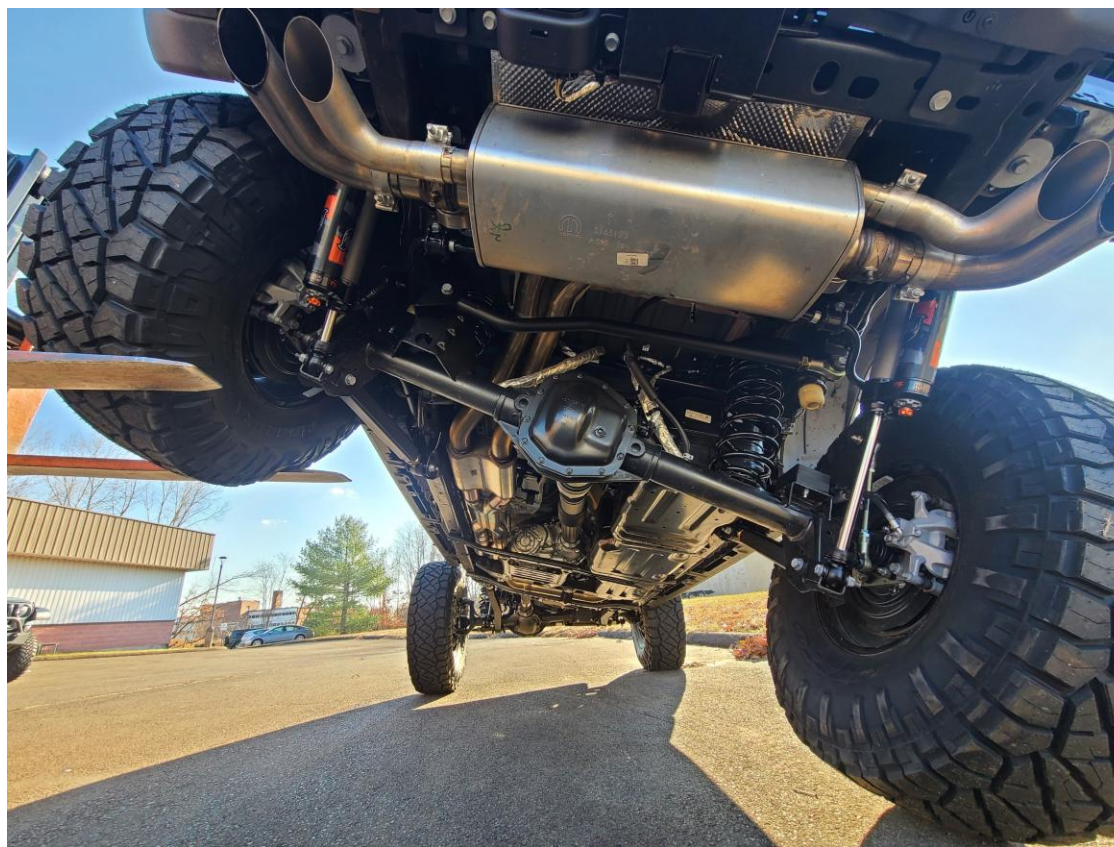

Figure 17: Front axle wiring harness/breather hose reconnected

REAR-END INSTALLATION

The following instructions are a generic guide to installing rear-end components. Please navigate to a specific product page for more in-depth instructions if you require a more specific, step-by-step guide



INSTALLATION INSTRUCTIONS

Take this product to a licensed professional if you are hesitant about the installation process!

The following instructions apply to the listed components below:

- Rear Coil Springs (1.5", 2.5", 3.5")
- Rear Adjustable Track Bar
- Rear Sway Bar End Links

The following instructions provide a basic guide for installing the rear-end components for the mid-arm lift kit!

If you purchased items separately or swapped in other components, your installation process will vary.

We strongly recommend having basic mechanic's hand tools, sockets, wrenches, vehicle jacks and stands, and other common tools readily available. Installing an aftermarket lift kit is a detailed process, and having the right tools on hand will ensure a smoother installation.

As always, feel free to contact us at any point during your installation - you can count on us to help!

INSTALLATION INSTRUCTIONS

17. Move the axle stands to the rear axle and position them on either side for support. Remove the tires for additional clearance.



Figure 18: Vehicle rear axle supported by lift and jack stands

INSTALLATION INSTRUCTIONS

18. Remove the rear bumper/wheel-well fender liners using an 8mm socket. There are 3 small screws per side. Save the liners and hardware. You will need to remove them to access the rear upper shock bolts.

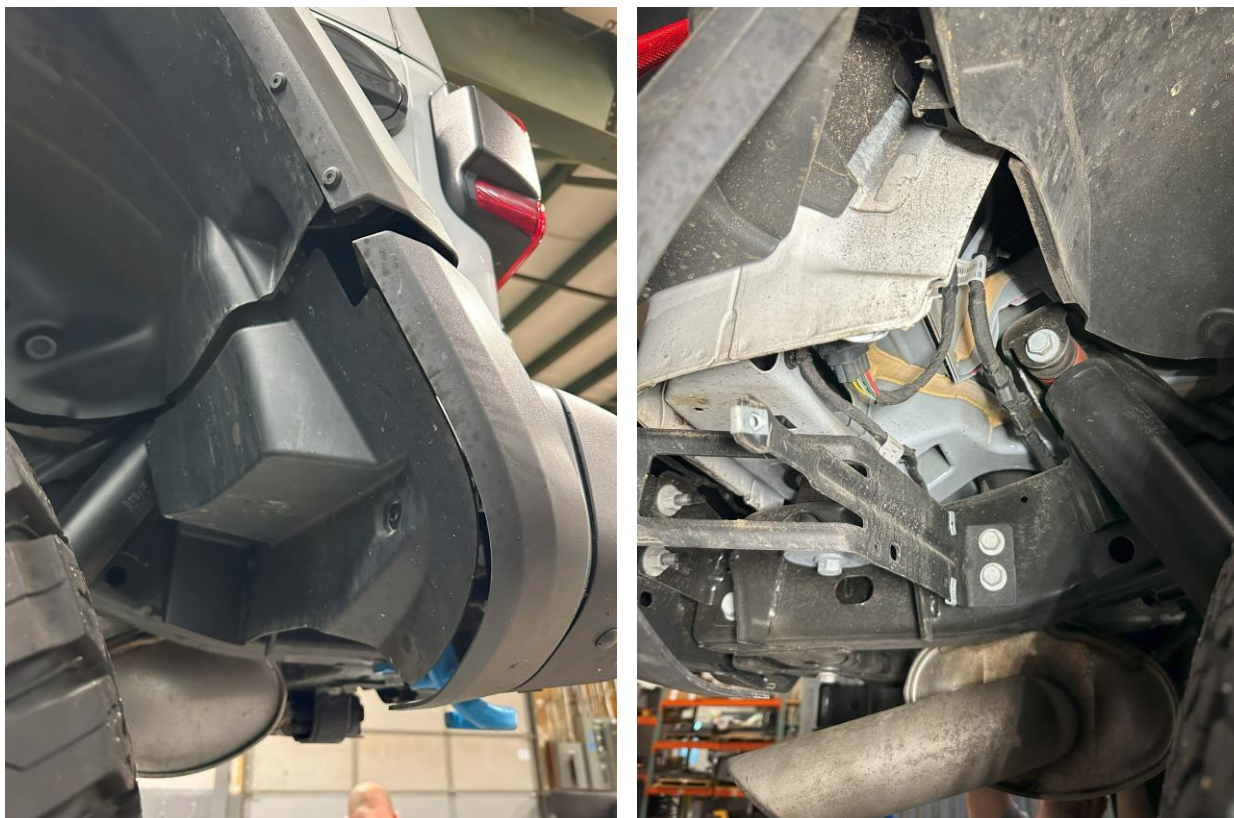

Figure 19: Rear bumper fender before and after removal

INSTALLATION INSTRUCTIONS

19. Remove the rear shocks. Remove the lower shock bolts using an 18mm socket. Save the hardware and put it off to the side. Move to the top of the shocks and remove the top shock bolts using an 18mm socket. It may be hard to get to, so push the fender liner out of the way and use a socket extension.

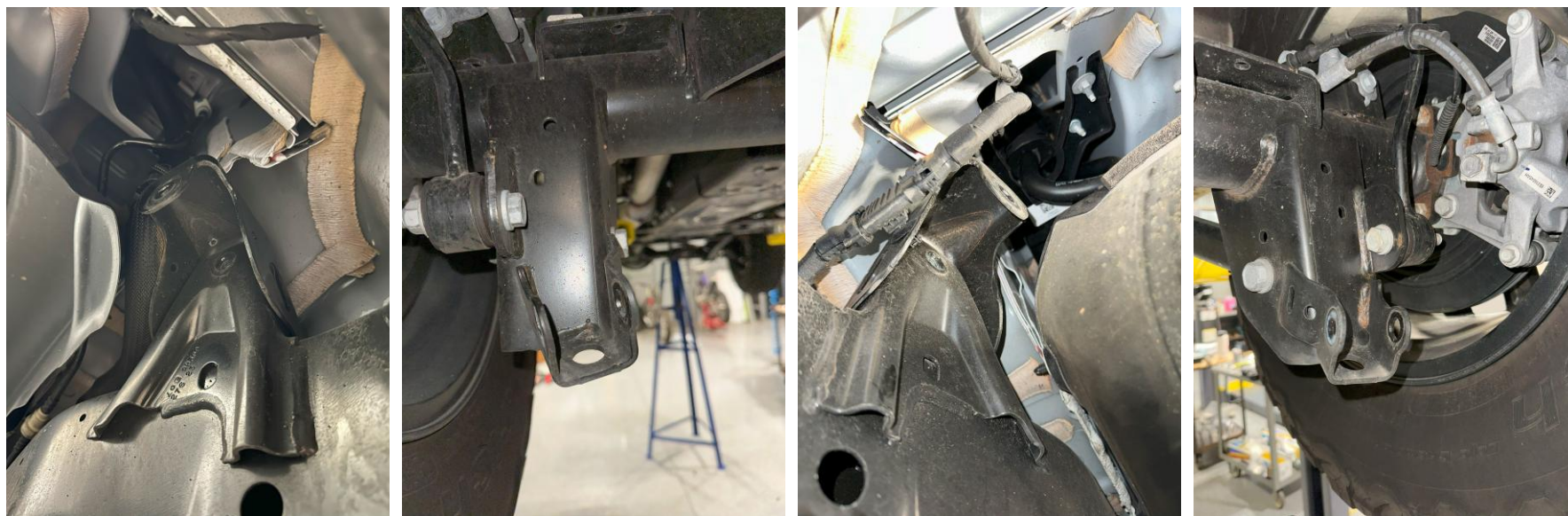

Figure 20: Rear passenger and driver-side shocks removed

INSTALLATION INSTRUCTIONS

20. Remove the factory rear sway bar end links. The socket size may vary depending on which vehicle, year, or aftermarket components you may already have installed. Remove the upper and lower bolts on both sides. You will **NOT** be re-using the hardware. **Remove the differential harness and breather hose. Be gentle with the clip, pull the lock-tab out first then slowly wiggle it off the sensor.**

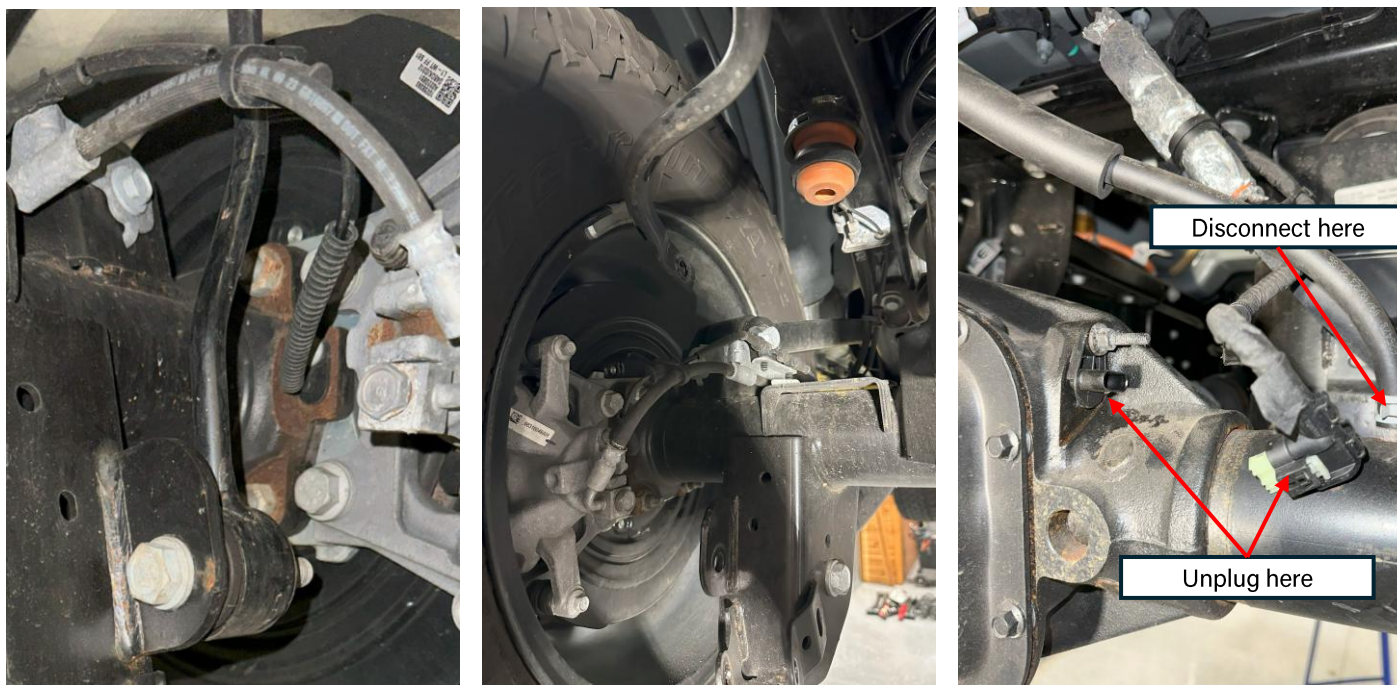

Figure 21: Rear sway bar end link before and after removal, and differential wiring harness removed

INSTALLATION INSTRUCTIONS

21. Remove the factory rear track bar. Start with the frame bracket bolt (21mm) and then the axle bolt (21mm). Save all factory hardware, as it will be reused.

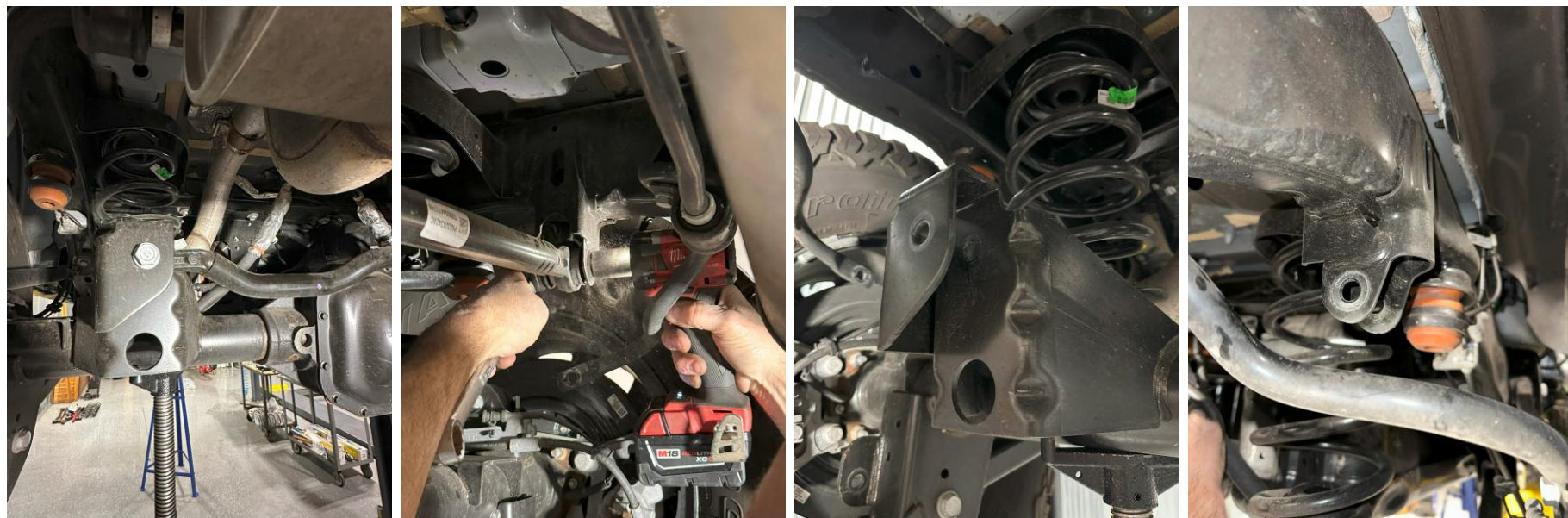

Figure 22: Rear track bar bolt locations before and after removal

INSTALLATION INSTRUCTIONS

22. Ensure there is enough play in the emergency brake cables before proceeding. Loosen any bracket retaining the cables. **Note that Clayton Off Road offers an Emergency Brake Cable Relocation Bracket (COR-1309502) and may be required for your specific setup.**



Figure 23: Emergency Brake Cable Relocation Bracket (sold separately)

INSTALLATION INSTRUCTIONS

23. Loosen all 8 rear control arm bolts, but **do not remove at this time.** You will need 18mm, 21mm, and 24mm sockets. **Make sure that the axle remains supported. Try to minimize any axle shift that may occur during this process.**

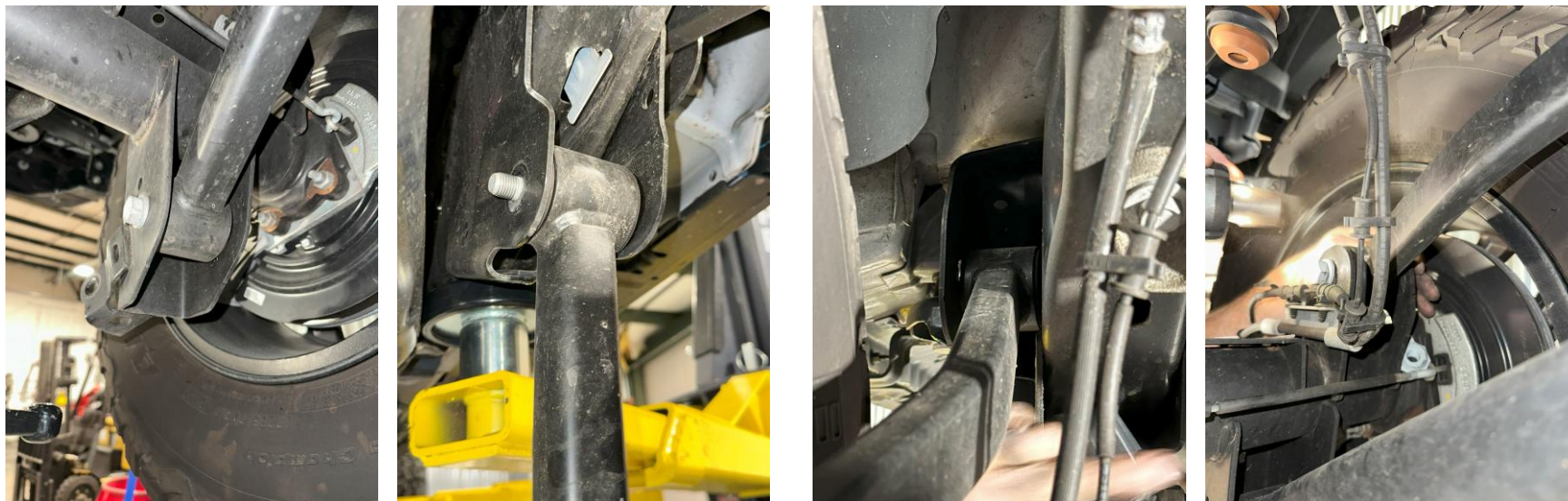

Figure 24: Rear control arm bolt locations (2 arms each side, 4 bolts per side, or 8 bolts total)

INSTALLATION INSTRUCTIONS

24. Carefully droop the axle by lowering the supporting jack stands (or raising the vehicle) and remove the factory springs. Using the OEM spring boot, install the new springs. Complete both sides at this time. Then, install the new springs. **The last two digits etched on the rear coils should read xxxxx51.** The rear coils in this kit **ARE** side-specific. Install the new springs while the axle is still dropped. Make sure that the springs are set properly on the coil perch and are retained in the upper spring mount. **In this case, the taller spring will have an "R" on it and must be used on the gas tank side.**



NOTE: Our HD coils are **NOT** side-specific. If you are installing HD coils on your heavier, fully loaded vehicle, you do not need to worry about left or right-side coil installation.

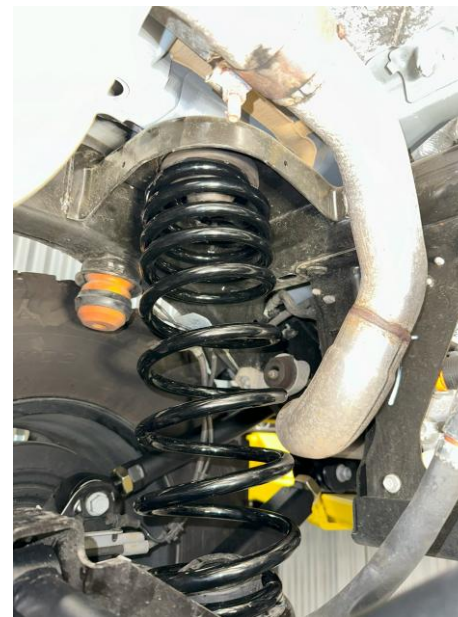

Figure 25: Axle drooped with old springs removed, and bump stops installed

INSTALLATION INSTRUCTIONS

25. Re-install the rear shocks or install new shocks. Install the upper bolt first, then the lower axle bolt. Use original hardware, unless your new shocks came with new hardware. If the aftermarket shocks came with a piggyback reservoir, install them at this time. **Do not torque yet.**

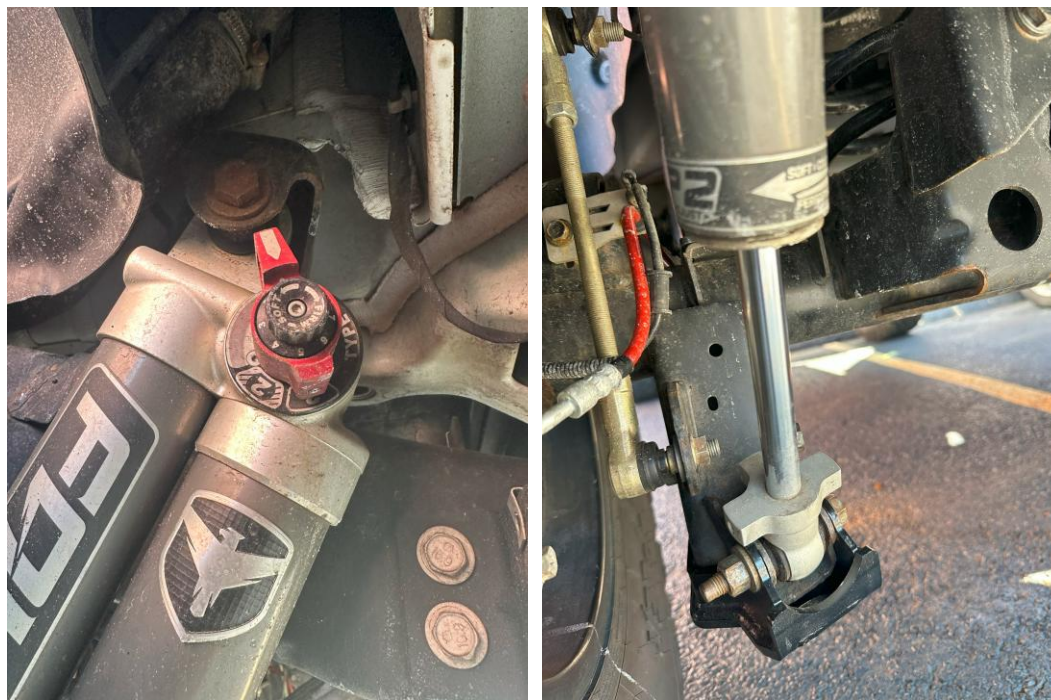

Figure 26: Rear shock top and bottom bolt installed loosely

INSTALLATION INSTRUCTIONS

26. Tighten the emergency cable bracket and ensure that is enough slack in the emergency brake cables. **Note that Clayton Off Road offers an Emergency Brake Cable Relocation Bracket (COR-1309502) and may be required for your specific setup.**



Figure 27: Emergency Brake Cable Relocation Bracket (sold separately)

INSTALLATION INSTRUCTIONS

27. Cut the new sway bar rods to the recommended length at each end following the **Sway Bar Quick Guide**. You can find this quick guide on our website, or at the end of these instructions. Assemble the sway bar end-links and use a 6mm hex key and an 18mm wrench to install. **Do not torque yet.**

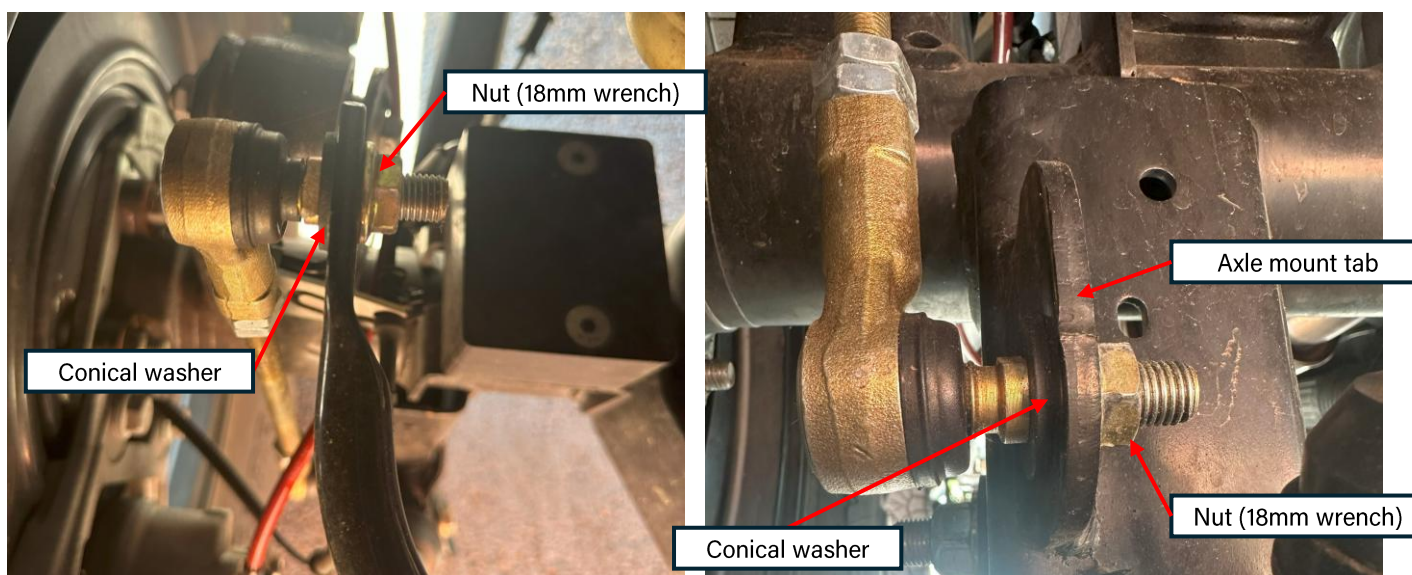

Figure 28: Sway bar end links installed on driver-side

*****Conical washers installed with the concave side facing towards the sway bar or tab, NOT the link!*****

INSTALLATION INSTRUCTIONS

28. Install the new rear track bar. Follow the **JL Suspension Quick Guide** for more information like starting lengths based on coil height. You can find this quick guide on our website under any JL lift kit listing, or at the end of these instructions.

Do not torque yet. Install the axle bolt first, then the frame bolt using the original hardware.

Install the rear track bar with the hump in the bar over top of the rear differential. You may need a ratchet strap to align the hole on the vehicle side, and recenter the axle.



Figure 29: New rear track bar installed

INSTALLATION INSTRUCTIONS

29. Reinstall the rear bumper/wheel-well fender liners using an 8mm socket. Use the original 3 screws per side.



Figure 30: Rear bumper fender re-installed

INSTALLATION INSTRUCTIONS

30. Reinstall the front axle wiring harness and breather tube.

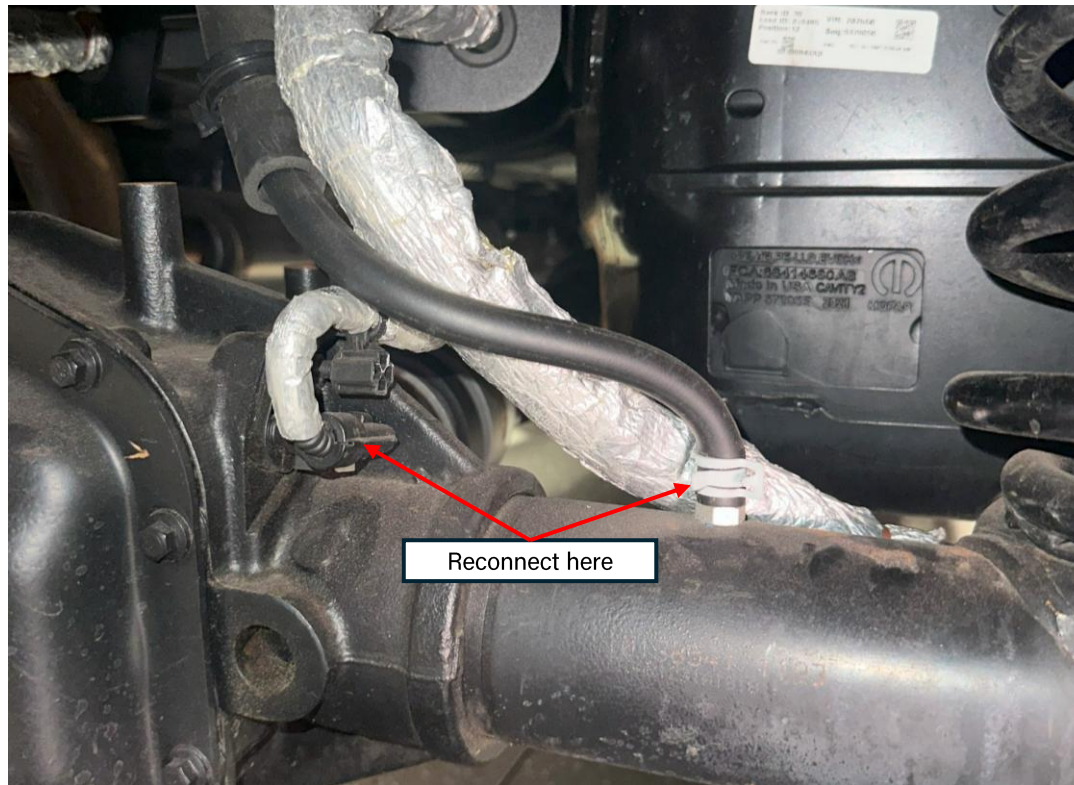

Figure 31: Differential wiring harness and breather tube reconnected

INSTALLATION INSTRUCTIONS

31. Refer to Table 2 for recommended front and rear track bar starting lengths applicable to this lift kit. The following lengths are recommendations and should only serve as a starting point for axle positioning. **The following measurements are given as "eye-to-eye" lengths.**

Table 2: COR Track Bar Length Specifications

Track Bar ID / Location	Minimum	1.5" Lift	2.5" Lift	3.5" Lift	4.5" Lift	Maximum
4509100 Front Track Bar	$33 \frac{9}{16}$ "	$33 \frac{15}{16}$ "	$34 \frac{1}{8}$ "	$34 \frac{1}{4}$ "	$34 \frac{7}{16}$ "	$35 \frac{3}{8}$ "
4509110 Rear Track Bar	$37 \frac{3}{8}$ "	$37 \frac{3}{4}$ "	$37 \frac{7}{8}$ "	38"	$38 \frac{3}{16}$ "	$39 \frac{1}{4}$ "



4509100 Front Track Bar



4509110 Rear Track Bar

INSTALLATION INSTRUCTIONS

32. Lower the vehicle back to the ground, and let it settle under its own weight. Verify the front and rear axle track.

Because all vehicles are different, Clayton Off Road only provides recommended lengths for all adjustable arms and track bars. These values should only serve as starting points, as fine-tuning of these adjustments is required to dial in the vehicle's alignment and ride quality.

To check the axle track, measure from a fixed point on the tire tread to another fixed point on the frame (or fender). You may use a straight-edge flush up against the tire and use it as a marker. This will allow you to pinpoint which direction the axle may need to go. Check both sides and compare both measurements. If one side is shorter or longer, adjust the track bar accordingly by removing the adjuster-end bolt and spinning the adjuster in/out half the difference of the two measurements. See the example below:



Axle track (rear driver side)



Axle track (rear passenger side)

In the case above, the axle was shifted to the driver's side nearly $\frac{1}{2}$ " more than the passenger's side.

This means that the rear track bar should be **shortened by $\frac{1}{4}$ "**, or until both measurements are equal.

INSTALLATION INSTRUCTIONS

33. **With the vehicle still under its own weight**, torque the front and rear track bar bolts (axle and frame end). Refer to Table 3 below for recommended torque specifications of each bolt, as well as the wrench size.

Table 3: COR Track Bar Torque Specifications

Suspension Bolt Location	Wrench Size	Torque (lb-ft)
Front Track Bar Bolt, Frame Bolt	21mm	130
Front Track Bar Bolt, Axle Bolt	21mm	130
Rear Track Bar Bolt, Frame Bolt	21mm	90
Rear Track Bar Bolt, Axle Bolt	21mm	90

INSTALLATION INSTRUCTIONS

34. With the vehicle **still under its own weight**, verify the front and rear caster/pinion angles. Verify that the caster angle at the front axle falls between 4.5-6 degrees. For the rear pinion angle, verify that the axle falls between 4.5-6 degrees.

Because all vehicles are different, Clayton Off Road only provides recommended lengths for all adjustable arms and track bars. These values should only serve as starting points, as fine-tuning of these adjustments is required to dial in the vehicle's alignment and ride quality.

If your angles are out of specification of this range, remove the upper control arm bolts (one arm at a time) and spin the adjuster in or out. **Spin the upper arms equally, starting with 1-2 full rotations at a time.** Re-measure the angle after each adjustment to make sure you do not overshoot/undershoot the specified range.

You may take a baseline measurement at the top of the c-knuckle, or on the direct top of the ball joint (assuming the vehicle is parked on a flat surface). This measurement location should give you a good idea of what your current angles are; however, it is highly recommended that you visit an alignment shop to verify these angles and **then adjust accordingly.**

Finally, please note that adjustable lower control arms will compensate for additional lift height by working to center the tires in the wheel well, also known as axle positioning. Lower control arms are not included in our Ride Right+ lift kits, but can be purchased separately as an upgrade at any time.

INSTALLATION INSTRUCTIONS

35. Please refer to Table 4 below for helpful control arm torque specifications, as well as helpful wrench sizes.

NOTE: Some of Clayton Control Arms come with upgraded hardware. Table 4 displays the torque specification for **OEM** hardware. **Verify the bolt torque specification for any upgraded control arm hardware in the individual control arm instructions found on our website.**

Table 4: OEM Control Arm Hardware Torque Specifications

Suspension Bolt Location	Wrench Size	Torque (lb-ft)
Front Upper Control Arm, Frame Bolt (Factory Size)	18mm, 21mm	80
Front Upper Control Arm, Axle Bolt (Factory Size)	18mm	80
Front Lower Control Arm, Frame Bolt (Factory Size)	21mm, 24mm	180
Front Lower Control Arm, Axle Bolt (Factory Size)	21mm, 24mm	180
Rear Upper Control Arm, Frame Bolt (Factory Size)	21mm	120
Rear Upper Control Arm, Axle Bolt (Factory Size)	21mm	95
Rear Lower Control Arm, Frame Bolt (Factory Size)	21mm	90
Rear Lower Control Arm, Axle Bolt (Factory Size)	21mm	90

INSTALLATION INSTRUCTIONS

36. Refer to Table 5 below for helpful torque specifications related to the front and rear shocks.

NOTE: Some aftermarket shocks come with upgraded hardware. Table 5 displays the torque specification for **OEM** shock hardware. **Always verify the bolt torque specification for any upgraded hardware before torquing.**

Table 5: OEM Shock Torque Specifications

Suspension Bolt Location	Wrench Size	Torque (lb-ft)
Front Upper Shock Bolt, Frame Bolt	18mm	80
Front Lower Shock Bolt, Axle Bolt	18mm	75
Rear Upper Shock Bolt, Frame Bolt	18mm	80
Rear Lower Shock Bolt, Axle Bolt	18mm	75

INSTALLATION INSTRUCTIONS

37. Refer to Table 6 below for helpful torque specifications related to the sway bar end links, as well as jam nuts at the track bars and track bars.

Table 6: COR Sway Bar End Link and Jam Nut Torque Specifications

Suspension Bolt Location	Wrench Size	Torque (lb-ft)
Sway Bar End-Link Nuts	18mm	100
Sway Bar Jam Nuts	3/4"	64
Upper Control Arm Adjuster Jam Nuts	1-1/2"	Very Tight
Track Bar Jam Nuts	1-1/2"	Very Tight

SWAY BAR QUICK GUIDE

Please review the following information so you can become familiar with our sway bar products

Continue to the next page for important installation notes

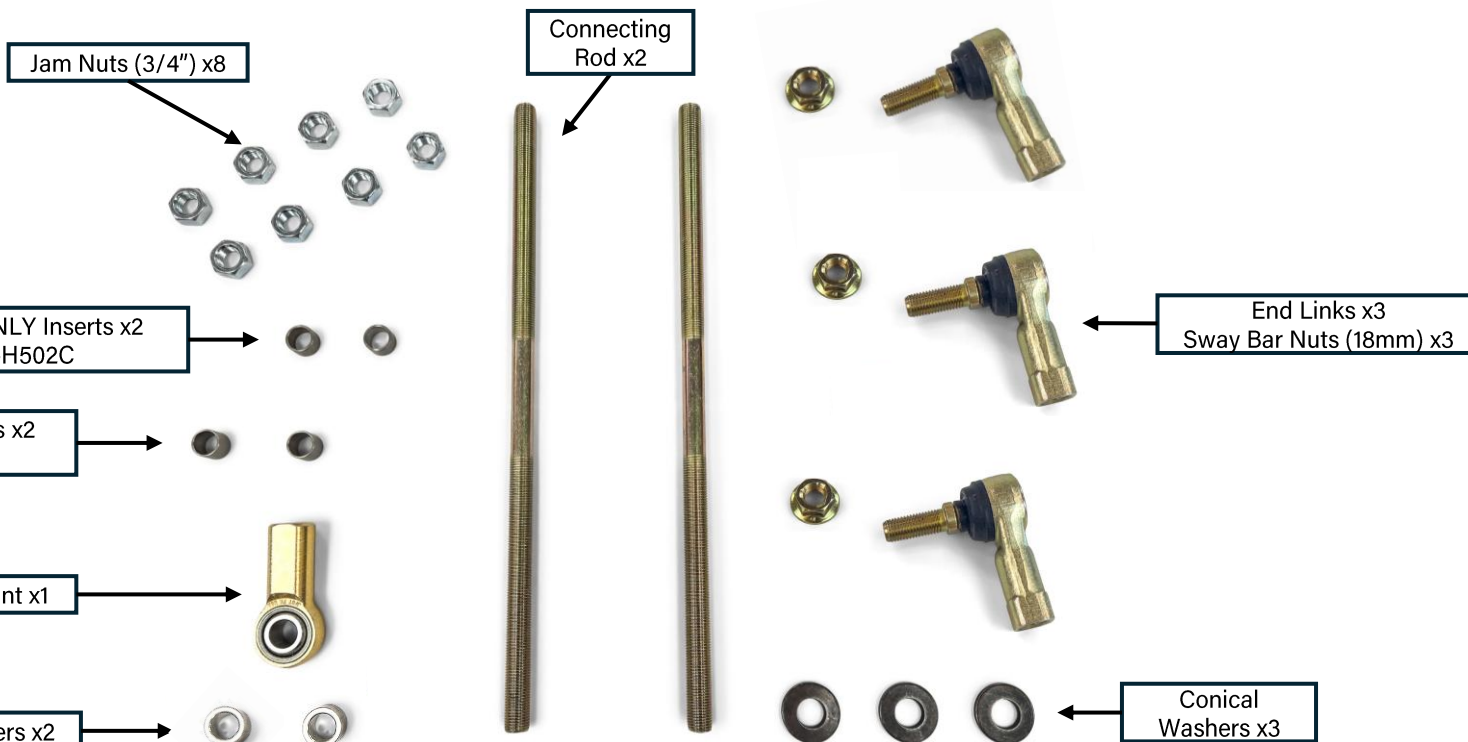

★ 2024+ Rubicon models with the solid version of the sway bar will need to utilize bushing inserts PN-AMP-HDW-H502C, which are inserted directly into the factory sway bar as shown on the next page

★ 2024+ non-Rubicon models with the hollow sway bar will need to utilize bushing inserts PN-AMP-HDW-H502B, which are inserted directly into the factory sway bar as shown on the next page

Bushing inserts are NOT necessary on 2018-2023 models

SWAY BAR QUICK GUIDE

NOTE: Jeep Gladiator (JT) and Jeep Wrangler (JL) Front Sway Bar End Links are intended to come with **three** studded rod ends and **one** single Heim Joint (as pictured on the previous page).

- **The single Heim Joint is to be used on the passenger side at the axle (bottom) for proper clearance with the factory double-shear bracket, meaning no additional modifications are necessary.**

NOTE: Conical washers provide an even greater surface area through beveled sides, distributing the force of the tightening nut while reducing vibrations and preventing the nut from coming loose.

- **Conical washers should be used on all models and years, with the concave side curving inward towards the sway bar.**

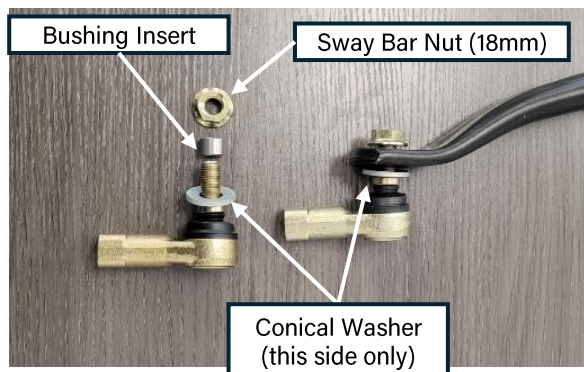

Lift Height	Stock	1.5" Lift		2.5" Lift		3.5" Lift		4.5" Lift	
Component		Center Length	Cut Each End	Center Length	Cut Each End	Center Length	Cut Each End	Center Length	Cut Each End
JK Front Sway Bar Link	5.250	8-1/4"	3-7/16"	9-1/4"	2-15/16"	10-1/4"	2-7/16"	11-1/4"	1-15/16"
JK Rear Sway Bar Link	8.750	10-3/4"	2-3/16"	11-3/4"	1-5/8"	12-3/4"	1-3/16"	13-3/4"	5/8"
JL Front Sway Bar Link	5.063	8-1/4"	3-7/16"	9-1/4"	2-15/16"	10-1/4"	2-7/16"	11-1/4"	1-15/16"
JL Rear Sway Bar Link	8.750	10-3/4"	2-3/16"	11-3/4"	1-5/8"	12-3/4"	1-3/16"	13-3/4"	5/8"
JT Front Sway Bar Link	5.063	8-1/4"	3-7/16"	9-1/4"	2-15/16"	10-1/4"	2-7/16"	11-1/4"	1-15/16"
JT Rear Sway Bar Link	10.625	12-5/8"	1-1/4"	13-5/8"	3/4"	14-5/8"	1/4"	15-5/8"	0"

Our newly improved end link design allows the installer to hold the stud with either a 6mm hex key or a 14mm wrench to tighten the nut. Either option works, as long as the sway bar end link nut is torqued to **90-100 ft-lbs**

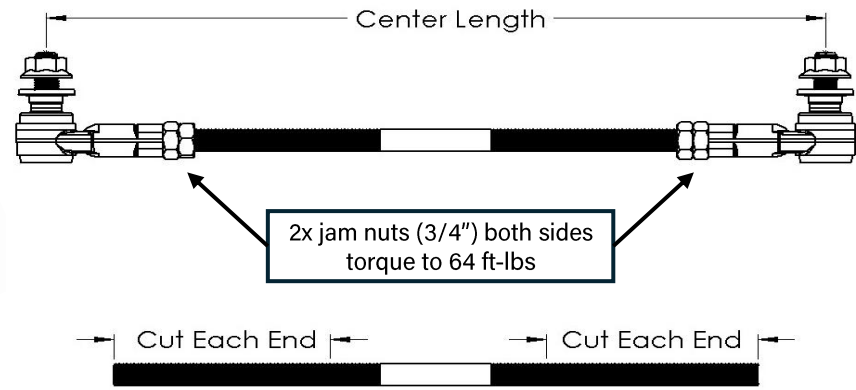
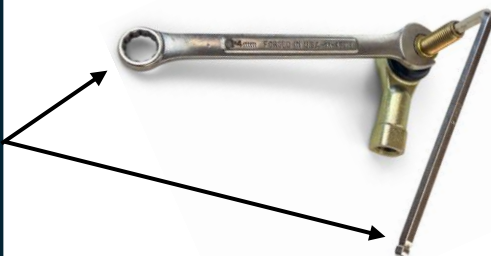

INSTALLATION INSTRUCTIONS

38. Tighten down the jam nuts on the upper control arms and track bars. Use a 1-1/2" wrench for these jam nuts with a breaker bar to gain additional leverage. Tighten all jam nuts down as tight as humanly possible.

Please note that not all wrenches are created with the same tolerances. If your wrenches are too loose around the jam nut, Clayton Off Road offers tight, wrap-around wrenches for purchase. Please search for the wrenches using the SKU's below.



Figure 32: COR Wrench-ends for control arm jam nuts and track bars (COR-2500125, COR-2500100)

INSTALLATION INSTRUCTIONS

39. Congratulations, you've completed our Ride Right+ Lift Kit Installation. Please see the post-installation checklist and confirm you have completed all of the steps before driving your vehicle.



POST-INSTALLATION CHECKLIST:

- Differential sensors/hoses (front and rear) are plugged back in
- Brake lines are put back into place and not damaged or stretched
- Caster set somewhere between 4.5-6 degrees
- Axles properly centered in wheel-well (axle track and position)
- All hardware is torqued to specification (see Tables 3-6)
- Control arm and track bar jam nuts are as tight as possible
- Sway bar end links are the proper length and tightened to specification
- Lug nuts are torqued to the manufacturer's specification
- A licensed shop has professionally aligned the vehicle
- Retorque all hardware after 500 miles of driving

