



102 S. Michigan Ave., Coldwater, MI 49036

Phone: 517-279-2135

Web/live chat: www.bds-suspension.com

E-mail: tech@bds-suspension.com

Part#: **014461**

Product: **4.5" Suspension System**

Application: **1987-1995 Jeep Wrangler YJ**

READ AND UNDERSTAND ALL INSTRUCTIONS AND WARNINGS PRIOR TO INSTALLATION OF SYSTEM AND OPERATION OF VEHICLE.

SAFETY WARNING BDS Suspension Co. recommends this system be installed by a professional technician. In addition to these instructions, professional knowledge of disassembly/ reassembly procedures and post installation checks must be known.

PRODUCT SAFETY WARNING Certain BDS Suspension products are intended to improve off-road performance. Modifying your vehicle for off-road use may result in the vehicle handling differently than a factory equipped vehicle. Extreme care must be used to prevent loss of control or vehicle rollover. Failure to drive your modified vehicle safely may result in serious injury or death. BDS Suspension Co. does not recommend the combined use of suspension lifts, body lifts, or other lifting devices.

You should never operate your modified vehicle under the influence of alcohol or drugs. Always drive your modified vehicle at reduced speeds to ensure your ability to control your vehicle under all driving conditions. Always wear your seat belt.

PRE-INSTALLATION NOTES

1. Special literature required: OE Service Manual for model/year of vehicle. Refer to manual for proper disassembly/ reassembly procedures of OE and related components.
2. Adhere to recommendations when replacement fasteners, retainers and keepers are called out in the OE manual.
3. Larger rim and tire combinations may increase leverage on suspension, steering, and related components. When selecting combinations larger than OE, consider the additional stress you could be inducing on the OE and related components.
4. Post suspension system vehicles may experience drive line vibrations. Angles may require tuning, slider on shaft may require replacement, shafts may need to be lengthened or trued, and U-joints may need to be replaced.
5. Secure and properly block vehicle prior to installation of BDS Suspension components. Always wear safety glasses when using power tools.
6. If installation is to be performed without a hoist, BDS Suspension Co. recommends rear alterations first.
7. Due to payload options and initial ride height variances, the amount of lift is a base figure. Final ride height dimensions may vary in accordance to original vehicle attitude. Always measure the attitude prior to beginning installation.

POST-INSTALLATION WARNINGS

1. Check all fasteners for proper torque. Check to ensure for adequate clearance between all rotating, mobile, fixed, and heated members. Verify clearance between exhaust and brake lines, fuel lines, fuel tank, floor boards and wiring harness. Check steering gear for clearance. Test and inspect brake system.
2. Perform steering sweep to ensure front brake hoses have adequate slack and do not contact any rotating, mobile or heated members. Inspect rear brake hoses at full extension for adequate slack. Failure to perform hose check/ replacement may result in component failure. Longer replacement hoses, if needed can be purchased from a local parts supplier.
3. Perform head light check and adjustment.
4. Re-torque all fasteners after 500 miles. Always inspect fasteners and components during routine servicing.

PARTS LIST

Part #	Qty	Description
084404R	1	Pitman Arm (Power Steering Only)
YJBS	4	Bump Stop Extensions
342701	1	Loctite

Brake Lines

22510	2	Front Brake Line
22513	1	Rear Brake Line
5188	3	Snap-in Brake Line Clip
B06103C	3	Brake Line Bracket
CCW-03-050	4	3/8" Brake Line Crush Washer
0990003		11.5 Nylon Cable Tie

Front & Rear Shackles

01367	8	Shackle Plate
01355	4	Center Shackle Spacer
3625RB	8	Frame Shackle Bushing
910	2	Bolt Pack
	6	1/2"-13 x 4-1/2" bolt
	6	1/2"-13 prevailing torque nut
	12	1/2" SAE flat washer

Front Sway Bar Disconnects

A121	2	Sway Bar Link
01305	2	Link Adapter
01316	2	Lanyard
01317	2	Clip
367	2	0.750 x 0.058 x 1.375 Sleeve
729	1	Bolt Pack
	2	9/16"-12 x 3" bolt
	2	9/16"-12 prevailing torque nut
	4	9/16" SAE flat washer
	2	1/2"-20 hex serrated flange nut
	2	1/2"-20 hex jam nut
	2	#10-16 x 5/8" self-drilling screw

Spring Components

15	4	0.750 x 0.083 x 2.950 Sleeve
37	4	0.750 x 0.109 x 2.985 Sleeve
3624RB	16	Spring Bushing
2124	2	4 Deg. Shim
560312FCP	2	5/16" x 3-1/2" Center Pin & Nut
905	1	Bolt Pack
	4	9/16"-12 x 4-1/2" bolt
	4	9/16"-12 prevailing torque nut
	8	9/16" SAE washer

Steering Stabilizer

5624	1	Stabilizer Cylinder
62147	1	0.625 x 0.075 x 1.375 Sleeve
51792	1	0.625 x 0.060 x 1.375 Sleeve
SB58RB	2	Hourglass Shock Bushing
P00837	1	Tapered Stud Kit

Track Bar Brackets

931203	1	Front Track Bar Bracket
940101	1	Rear Track Bar Bracket
5	1	0.875 x 0.156 x 1.675 Sleeve
904	1	Bolt Pack
	2	5/16" USS flat washer
	1	5/16"-18 x 1" bolt
	1	5/16"-18 prevailing torque nut
	1	1/8" x 1-1/4" cotter pin
	6	7/16" USS flat washer
	2	12mm-1.75 x 70mm bolt
	1	12mm-1.75 x 60mm bolt
	3	12mm-1.75 prevailing torque nut
	6	1/2"-13 x 3" bolt
	6	7/16" USS flat washer

Transfer Case Drop

01837	2	Transfer Case Drop Spacer
200-03369	4	Spacer Tube End Cap
YJTC6	6	Transfer Case Drop Conical Washer
B12X3G5	6	1/2"-13 x 3" Transfer Case Bolt
W76USS	6	7/16" Flat Washer

U-Bolts

122120634R	6	1/2" x 2-1/2" x 7" Round U-bolt
123250700R	2	1/2" x 3-1/4" x 7" Round U-bolt
N12FH	16	1/2" High Nut
W12S	16	1/2" SAE flat washer

INSTALLATION INSTRUCTIONS

Note: This kit includes new braided stainless steel brake lines. Installation of these lines requires the entire brake system to be bled following the completed installation and prior to operating the vehicle. Consult your owner's manual for the proper brake fluid to use for your vehicle. Fluid is not included in this kit.

Front Installation

1. Park the vehicle on a clean, flat surface and block the rear wheels for safety.
2. Disconnect the front track bar from the axle. Retain hardware.
3. Disconnect the rear track bar from the axle. Retain hardware.
4. Raise the front of the vehicle and support with jack stands under the frame rails just behind the front spring hangers.
5. Remove the wheels.
6. Disconnect the OE steering stabilizer from the axle and from the drag link. Retain the axle mounting bolt, discard the rest.
7. Disconnect the drag link from the pitman arm. Remove the cotter pin and nut. Free the tie rod end taper using a pickle fork. Retain nut.
8. Remove the nut and washer mounting the pitman arm to the steering box. Remove the pitman arm from the steering box using a pitman arm puller. Note the indexing of the pitman arm before removal.
9. Install the new pitman arm on the steering box in the same orientation as the OE was taken off. Fasten with the OE nut and washer. Torque nut to 185 ft-lbs.
10. Disconnect the driver's side front rubber brake hose from the frame. Disconnect the hose from the steel fitting at the frame and the brake caliper. Retain banjo bolt removed at the brake caliper.
11. Ensure that the old crush washer is removed from the caliper and that the brake line mounting surface is clean. Attach the new brake line to the caliper using two new crush washers on each side of the hose fitting and the OE banjo bolt. Tighten the banjo bolt to 20 ft-lbs. (Fig. 1)

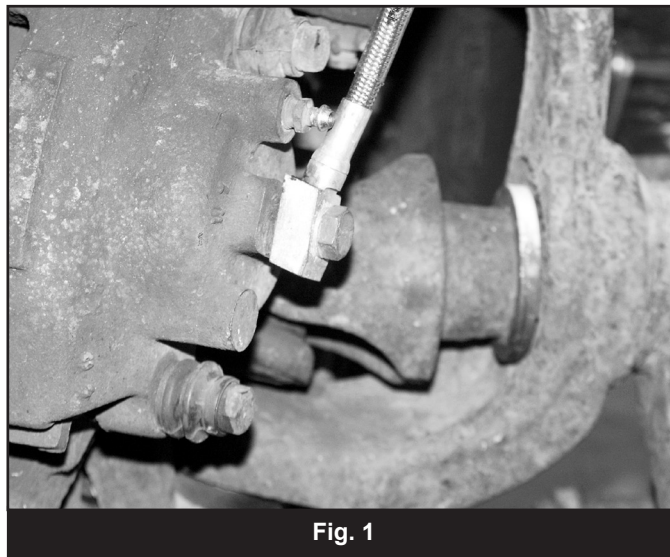

12. Install the new brake line mounting bracket to the new hose and then attach the hose to the steel line at the frame. Attach the bracket to the frame in the original brake line mounting position with the OE bolt. Torque bolt to 18 ft-lbs. (Fig. 2)

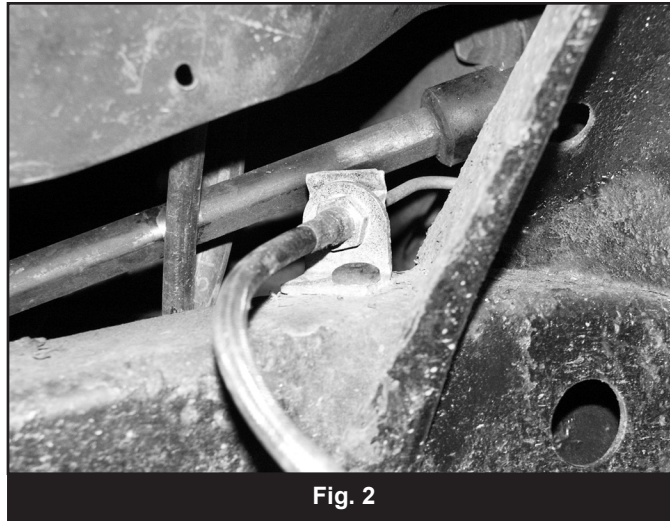

Fig. 2

13. Retain the brake line to the new bracket with the provided brake line clip.
14. Repeat brake line installation on the passenger's side of the vehicle.
15. Support front axle with a hydraulic jack.
16. Remove the OE shocks. Discard the shocks and upper hardware. Retain the lower hardware.
17. Disconnect the sway bar links from the sway bar and spring plates. Retain all mounting hardware. The mount at the sway bar will require a pickle fork to release the tapered stud from the sway bar.
18. Remove the driver's side spring u-bolts and u-bolt plate. Discard the u-bolts and retain the u-bolt plate.
19. Remove the spring-to-shackle pivot bolt and the spring-to-hanger bolt and remove the spring from the vehicle. Discard hardware and spring.
20. Remove the shackle-to-frame pivot bolt and remove the shackle plates from the vehicle. Remove the OE frame shackle bushings. Discard hardware, bushings and shackles.
21. Apply grease to the new spring bushings (3624RB) and install in the new front springs (004351). Grease one (37) sleeve (1/2" ID) and one (15) sleeve (9/16" ID) and insert in opposite spring eyes. The small (37) sleeve will mount to the shackles.
22. Apply grease to the new frame shackle bushings (3625RB) and install in the frame. Grease and install a (37) sleeve in the bushings.
23. Loosely install two new front shackle plates (curved) to the frame with a 1/2" x 4-1/2" bolt, nut and 1/2" SAE washers from bolt pack #910. The two closest holes in the plate will go toward the spring. The bend in the shackle will go down and toward the front of the vehicle. (Fig. 3) Loosely install the shackle spacer in the middle holes on the shackle plate and retain with 1/2" hardware from bolt pack #910.

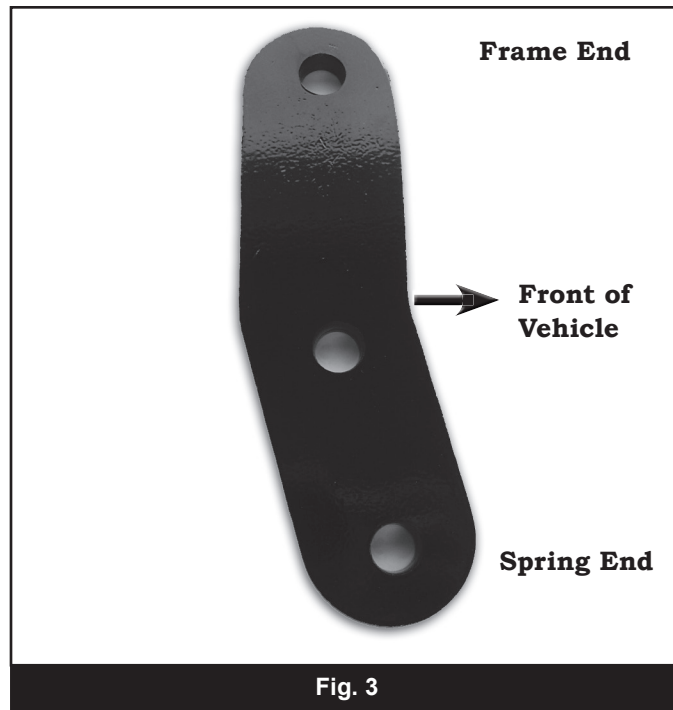

Fig. 3

24. Attach the spring to the shackles with a $\frac{1}{2}$ " x 4-1/2" bolt, nut and $\frac{1}{2}$ " SAE washers from bolt pack #910. Leave hardware loose. Be sure to attach the end of the spring with the small ID sleeve.
25. Attach the spring to the hanger with a $\frac{9}{16}$ " x 4-1/2" bolt, nut and $\frac{9}{16}$ " SAE washers from bolt pack #905. Leave hardware loose.
26. Clean the spring mounting surface on the axle and lower the axle to the spring. Position the new bump stop on the axle tube and slide the new u-bolt over the tab on the bump stop. Install a 3-1/4" wide u-bolt over the differential housing and the 2-3/4" wide over the bump stop tab. Fasten the u-bolts with $\frac{1}{2}$ " high nuts and $\frac{1}{2}$ " SAE washers. Snug hardware. Final u-bolt torque will be down with the vehicle weight on the springs.
27. Repeat spring removal/installation on the passenger's side of the vehicle.
28. Install the new front track bar bracket on the original axle mount so that the tab fits inside the webs of the casting. Secure the bracket with a 12mm x 60mm bolt, nut and $\frac{7}{16}$ " washers from bolt pack #904. Torque bolt to 55 ft-lbs. (Fig. 4)

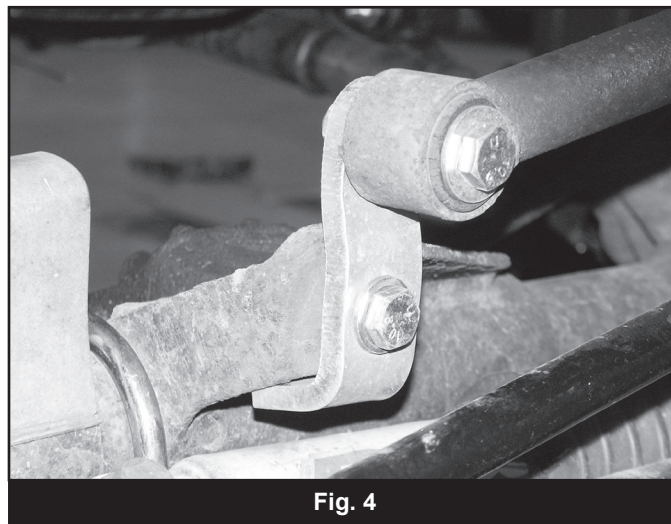
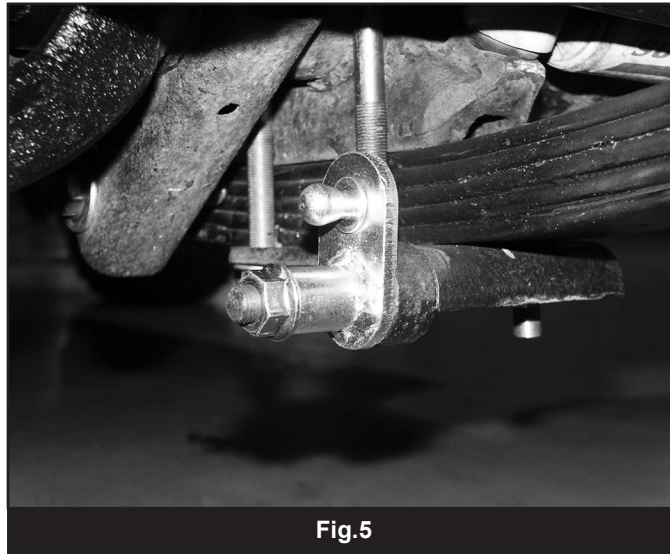

Fig. 4

29. Install the new lower ball stud adapter to the OE sway bar link axle mount with a provided 1/2" flange nut (Fig 5).



30. Rotate the bracket so it is straight up (ball stud up) and torque the nut to 65 ft-lbs.

31. Lightly grease and install the provided hourglass bushings in the ends of the new sway bar links. Lightly grease and install the provided sleeves into the bushings.

32. Install the provided 1/2" jam nut then the spring loaded disconnect assembly on the threaded end of the new link. Thread the nut and assembly all the way on to the link (Fig 6).

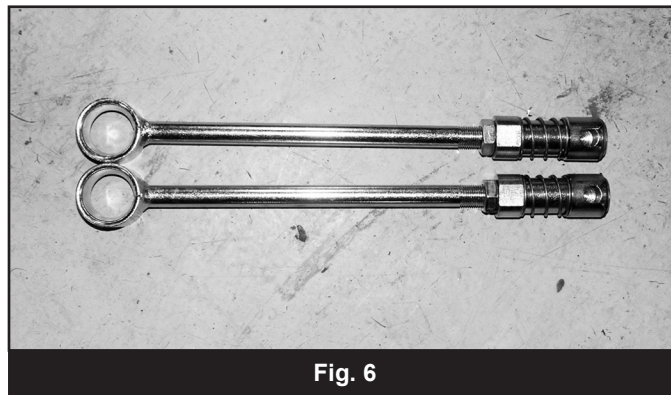

33. Attach the sway bar link assembly to the sway bar with the provided 9/16" x 3" bolt, nut and 9/16" SAE washers, running from the inside out. Torque bolt to 75 ft-lbs. The sway bar link will mount to the outside of the sway bar (Fig 7).



34. Ensure that the vehicle is setting level. Pull the spring collar up on the disconnect end and attach it to the ball stud (Fig 8). Make sure that the disconnect end stud hole is square with the ball stud and tighten the jam nut against the disconnect end. The disconnects allow for ½" of adjustment (1/2" longer from full-bottomed out). If necessary, adjust the links side-to-side to compensate for any unevenness in the vehicle allowing for the easiest possible disconnecting of the ends.

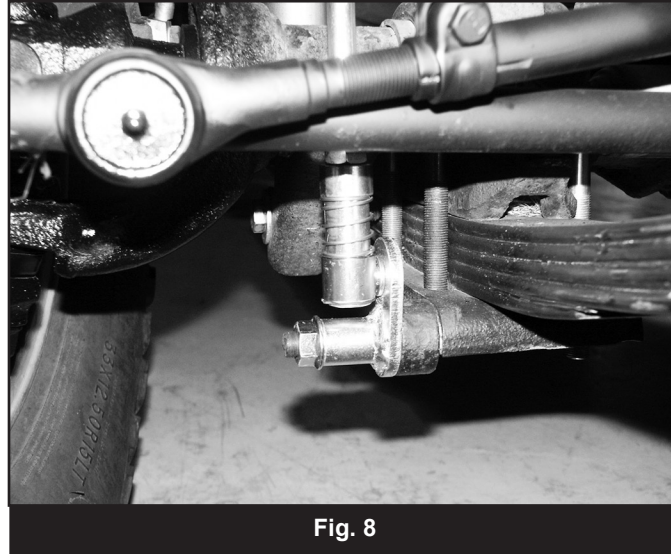

35. Check the jam nuts to be sure they are securely locked off. Disconnect both end links and fold them up against the sway bar. Clip the provided lanyard/clip assembly around the sway bar/end link and find the best position for mounting the lanyard. This position will vary from vehicle to vehicle and with different suspension setups. Use your best judgment. Use the provided self-drilling screws to mount the lanyard to the body/frame.
36. With the lanyards installed reconnect the sway bar links to the axle. The lanyards can be reattached to themselves so that they remain out of the way of moving parts when not in use.
37. Attach the drag link to the pitman arm with the OE castellated nut and new cotter pin from bolt pack #904. Torque nut to 55 ft-lbs. DO NOT loosen nut in order to install the cotter pin.
38. Install the new steering stabilizer mounting stud in the OE drag link tapered hole with the provided hardware. Attach the body end of the stabilizer to the axle with the OE bolt and the opposite end to the new stud with the provided hardware.
39. Install the new shocks using the OE lower hardware and new upper hardware. Torque the lower hardware to 50 ft-lbs and tighten the upper hardware until the bushings begin to swell.
40. Install the wheels and lower the vehicle to the ground.
41. Bounce the front of the vehicle to settle the suspension. Torque the u-bolts to 70-85 ft-lbs. Torque the 9/16" hanger bolts to 95 ft-lbs and ½" shackle bolts to 65 ft-lbs.
42. Attach the track bar to the track bar relocation bracket with a 12mm x 70 mm bolt, nut and 7/16" USS washers from bolt pack #904. Turn the steering wheel to help align the holes. If necessary the track bar can be loosened at the frame to provided extra movement. Torque track bar bolts to 55 ft-lbs.

Transfer Case Lowering Kit

43. Support the transfer case skid plate with a floor jack.
44. Locate both of the transfer case drop spacer tubes and the (4) plastic caps. Lightly tap the caps squarely into the ends of the spacer tubes until fully seated.
45. Loosen but do not remove all six skid plate mounting bolts.
46. Remove the three bolts on the drivers's side mounting the skid plate to the frame. Slowly lower the jack until one of the spacers tubes can be installed between the skid plate and the frame. With the large holes facing up, line up the holes at each mounting bolt location.

47. Attach the skid plate and transfer case drop with the provided 1/2" x 3" bolts, 7/16" USS washers, and conical washers YJTC6 (Fig 9). Leave bolts loose.

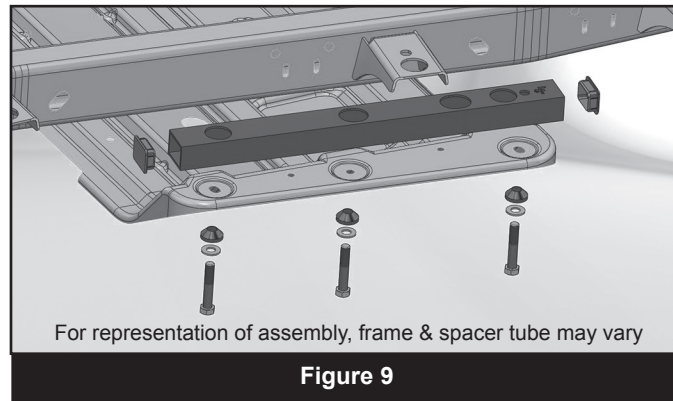

48. Repeat the procedure for the passenger's side of the skid plate.
49. With all six bolts/spacer installed, torque the bolts to 65 ft-lbs.

Note: Check for any restriction of the manual transmission shifter and transfer case lever and remedy. It may be necessary to move the boot rearward and/or notch floor to eliminate restriction or component failure may result.

REAR INSTALLATION

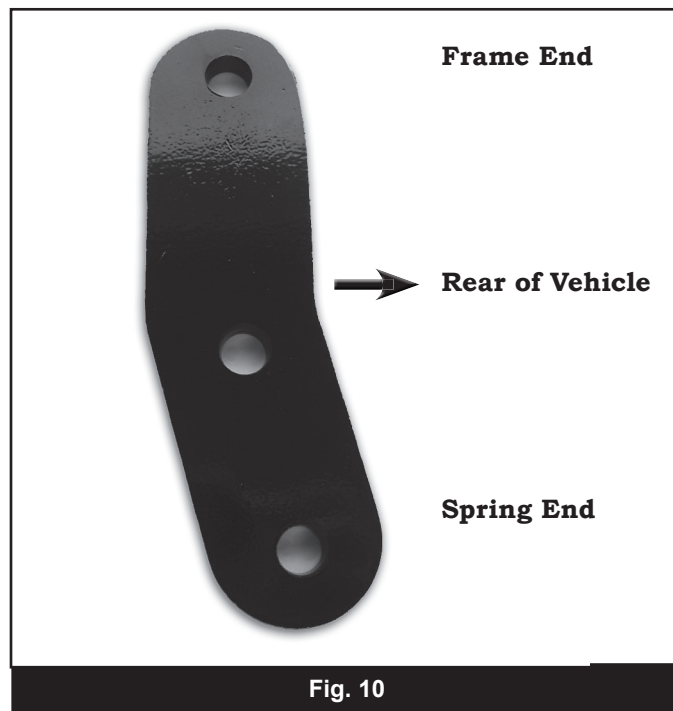

50. Block the front wheels for safety.
51. Disconnect the track bar from the rear axle. Retain mounting hardware.
52. Raise the rear of the vehicle and support with jack stands under the frame rails just ahead of the rear spring hangers.
53. Remove the wheels.
54. Disconnect the rubber brake hose from the steel brake line on the driver's side frame rail.
55. Disconnect axle tube breather from the brake line junction block on the driver's side axle tube. Disconnect the brake lines from the junction block. Disconnect the junction block from the axle by removing the breather bolt. Retain the breather bolt.

56. Attach the axle brake lines to the new brake line junction block. Attach the junction block to the axle with the OE breather bolt. Torque bolt to 25 ft-lbs. Install breather hose. (Fig. 11)

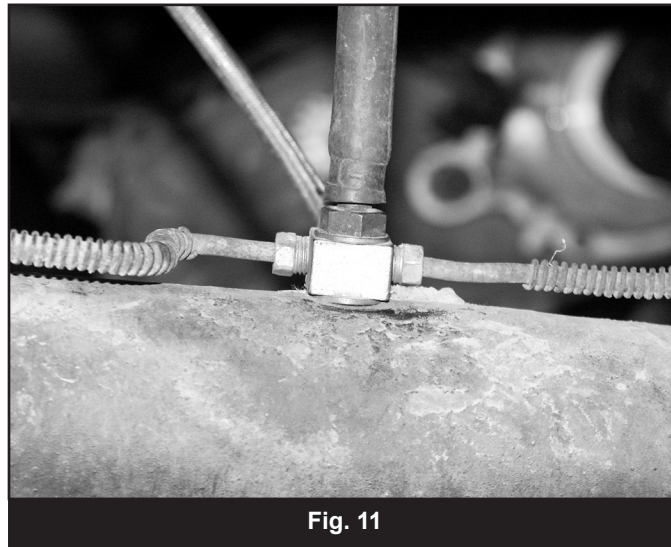

57. Attach the new brake line to steel brake line at the driver's side frame rail.
58. Remove the OE shocks. Retain all mounting hardware.
59. Remove the driver's side spring u-bolts and u-bolt plate. Discard the u-bolts and retain the u-bolt plate.
60. Remove the spring-to-shackle pivot bolt and the spring-to-hanger bolt and remove the spring from the vehicle. Discard hardware and spring.
61. Remove the shackle-to-frame pivot bolt and remove the shackle plates from the vehicle. Remove the OE frame shackle bushings. Discard hardware, bushings and shackles.
62. Install the rear axle shims on the rear springs. The shims either be installed by bolting directly to the leaf pack via the provided 5/16" center pins or the holes in the shims can be drilled out to slide over the existing center pin head on the spring. If using the later method, ensure that there is enough center pin protruding from the shim to engage in the OE axle spring perch. The thick end of the shim will go toward the front of the vehicle. Note: If vehicle is equipped with (or will be before operating vehicle) a slip yoke eliminator and CV drive shaft, a larger degree shim may be required to properly align the driveline.
63. Apply grease to the new spring bushings (3624RB) and install in the new rear springs (004359 OR 004351). Grease one (37) sleeve (1/2" ID) and one (15) sleeve (9/16" ID) and insert in opposite spring eyes. The small (37) sleeve will mount to the shackles.
64. Apply grease to the new frame shackle bushings (3625RB) and install in the frame. Grease and install a (37) sleeve in the bushings.
65. Loosely install two new rear shackle plates (curved) to the frame with a 1/2" x 4-1/2" bolt, nut and 1/2" SAE washers from bolt pack #910. The two closest holes in the plate will go toward the spring. The bend in the shackle will go down and toward the rear of the vehicle. (Fig. 10) Loosely install the shackle spacer in the middle holes on the shackle plate and retain with 1/2" hardware from bolt pack #910.
66. Attach the spring to the shackles with a 1/2" x 4-1/2" bolt, nut and 1/2" SAE washers from bolt pack #910. Leave hardware loose. Be sure to attach the end of the spring with the small ID sleeve.
67. Attach the spring to the hanger with a 9/16" x 4-1/2" bolt, nut and 9/16" SAE washers from bolt pack #905. Leave hardware loose.
68. Clean the spring mounting surface on the axle and lower the axle to the spring. Be sure that the thick end of the shim is toward the front of the vehicle. Position the new bump stop on the axle tube and slide the new u-bolt over the tab on the bump stop. Fasten the u-bolts with 1/2" high nuts and 1/2" SAE washers. Snug hardware. Final u-bolt torque will be down with the vehicle weight on the springs.
69. Repeat spring removal/installation on the passenger's side of the vehicle.
70. Install the provided rear track bar relocation bracket in the OE axle mounting. (Fig. 12)

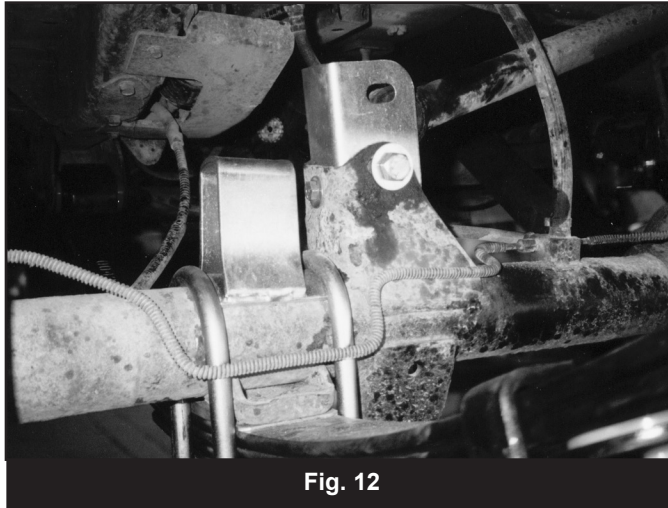

Fig. 12

71. Install a 5/16" x 1" bolt, nut and washers from bolt pack #904 in the small existing hole in the OE axle bracket and the corresponding hole in the new bracket. Leave hardware loose.
72. Position the provided (5) sleeve in the bracket. Fasten the bracket to the axle with a 12mm x 70mm bolt, nut and 7/16" USS washers through the original mounting hole, new bracket and sleeve. Torque the 12mm bolt to 55 ft-lbs and the 5/16" bolt to 18 ft-lbs.
73. Install the new shocks with the OE hardware. Torque shock hardware to 55 ft-lbs.
74. Install the wheels and lower the vehicle to the ground.
75. Bounce the rear of the vehicle to settle the suspension. Torque the u-bolts to 70-85 ft-lbs. Torque the 9/16" hanger bolts to 95 ft-lbs and 1/2" shackle bolts to 65 ft-lbs.
76. Install the rear track bar in the new bracket with the OE hardware. Push on the sides of the vehicle to aid in aligning the holes. It may be necessary to loosen the upper track bar mounting bolt to allow the track bar to move easier for alignment.
77. Torque the rear track bar bolts to 55 ft-lbs.

POST-INSTALLATION

78. Bleed the entire brake system using the appropriate fluid (see owner's manual).
79. Check all hardware.
80. Check hardware after 500 miles.
81. Do a complete steering sweep to check for proper clearance of all suspension components. Use the provided zip ties to tie the brake lines out of the way if necessary.
82. Adjust head lights.
83. Adjust the steering wheel using the adjustment collar on the drag link at the pitman arm.
84. A front end alignment is recommended.

NOTICE TO DEALER/INSTALLER

These instructions, the warning card, and included decals must be given to the owner of this BDS Suspension product.

For questions, technical support and warranty issues relating to this BDS Suspension product, please contact your distributor/installer before contacting BDS Suspension directly.

Sold/Installed by: